

Design and Access Statement

Vol. 2 - Detailed Component

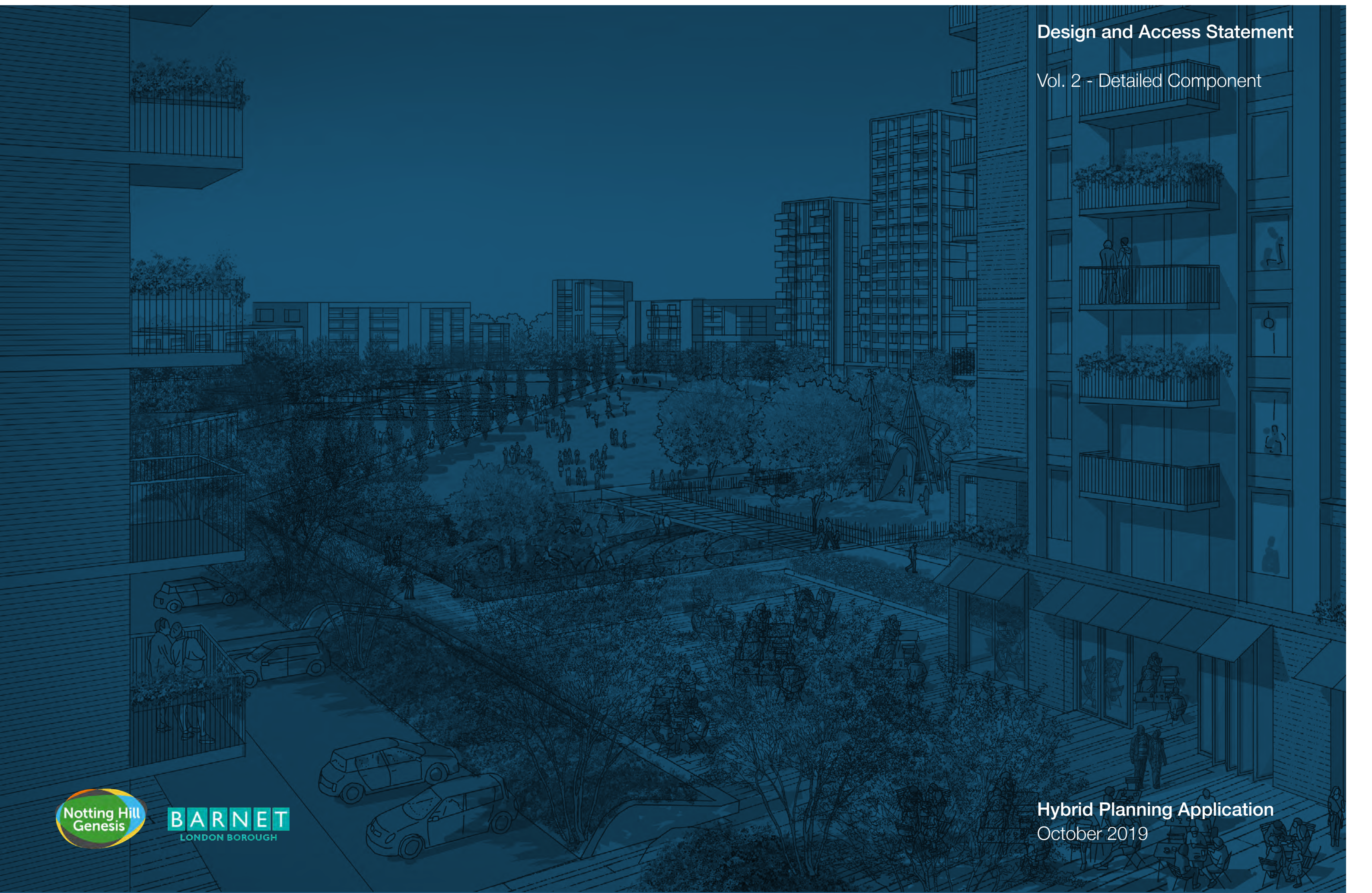

Hybrid Planning Application
October 2019

Team

ADAS

Arboricultural consultant
Ecology & historic environment

Architecture in Perspective

Visualisation

Arcadis

Cost consultant

BRE

Wind consultant

Curtins Consulting Engineering

Structural & Civil engineer

FDS

Fire consultant

Fellows International Limited

UXO Survey consultant

HGH Consulting

Planning consultant / Environmental Statement

Inner Circle Consulting

Project management

Max Fordham

MEP Engineer / Sustainability / Noise consultant

Notting Hill Genesis

Client

Patel Taylor

Architect / Landscape Architect

Point 2

Daylight / Sunlight / RoL consultant

Propernomics

Socio-economics and health consultant

Savills

Sales valuation

WSP

Transport / Air quality consultant

Planning Documentation

Design and Access Statement
Vol. 1 - Outline Component

Design and Access Statement
Vol. 2 - Detailed Component

Design Guidelines

Planning Statement

Statement of Community Involvement

Environmental Statement

Drainage Strategy

Flood Risk Assessment

Masterplan Daylight and Sunlight Report

Internal Daylight Report

Ecological Walkover

Unexploded Ordinance Desk Study

Outline Fire Safety Strategy

Transport Assessment

Framework Residential Travel Plan

Framework Workplace Travel Plan

Local Model Validation Report

Outline Delivery and Servicing Management Plan

Outline Construction Logistics Plan

Outline Construction Environmental Management
Plan

Outline Site Waste Management Plan

Sustainability Statement

Planning Utilities Statement

Energy Assessment

Historic Desk-Based Assessment

Arboricultural Method Statement

Arboricultural Impact Assessment

Wind Microclimate Assessment



Preface

Overview

Regeneration history:

The regeneration of the Grahame Park Estate, located in north west London in the London Borough of Barnet (**LBB**) began near the turn of the 21st Century with a successful residents' ballot (2003) which led to the submission of an Outline masterplan application (W/01731JS/04). The application was permitted in 2007, and established several zones of the estate to be regenerated in successive phases.

The masterplan was in the process of being delivered when, in response to the 2010 Area Action Plan, a new and intensified masterplan was consulted on and developed in support of a Supplementary Planning Document (**SPD**) published in 2016.

The SPD classified all zones which had already been built out as **"Stage A"**, with the remaining zones collectively known as **"Stage B"**. The SPD subdivided Stage B into new land-use Plots numbering from 10 to 21.

A full planning application for 1,083 homes (17/2840/OUT) based on the principles of the SPD was prepared and submitted for approval in 2017. After a recommendation for approval by LBB, the Mayor of London directed refusal of the proposals citing the under-provision of Social for Rent homes and too low contribution to transport infrastructure as primary reasons. The Mayor invited a resubmission of a scheme which:

"...better optimises the site, providing a denser, high quality housing development with no net loss of affordable housing on a like for like basis; and is able to fully mitigate its impact on the transport network."

Response:

On review, the Applicant decided that it would not be possible to amend the existing application to satisfy the Mayor's requirements, and instead invited a new design team to prepare proposals with a brief to meet them.

This application

This Hybrid Planning Application with some matters reserved is being submitted by Choices for Grahame Park (**CfGP** - **"The Applicant"**) for the redevelopment of **Grahame Park Stage B; Plots A:Q** (**"The Proposed Development"**).

Approach

Holistic placemaking:

In order to satisfy the concerns raised by the Mayor, the Proposed Development needs to include more homes in a scheme of greater density that delivers genuinely affordable homes for the residents of Barnet.

The Applicant and design team are firm believers in the transformative power of design in the built environment.

The Architect, Patel Taylor, works almost exclusively in London and has been the lead designer behind many of the largest urban regeneration projects in the city, creating successful places with the challenges of dense urban living.

"Placemaking defines our work. Our integrated approach to architecture, landscape and urban design proposes a framework that helps repair and reinforce a sense of place."

From the careful analysis of site, brief and cost, we create bespoke architectural responses that add value for the client and heightened delight for the communities that we serve."

In essence, we believe that architecture should be clear and logical; spaces should be suited to their purpose, enhanced by material and craft, light and shade."

Objectives

The Proposed Development sets out to:

- Create a successful place in which people will want to live, work and visit.
- Build on the successful aspects of the previous scheme by creating a clear hierarchy of streets and open spaces, with landscape and building typologies creating distinct character areas and neighbourhoods.
- Improve access to walking, cycling and public transport in line with 'Healthy Streets'.
- Create an inclusive place designed to be enjoyable in use for everyone.
- Respond to residents' key needs by re-imagining Heybourne Park open space as a safe, inviting family-friendly place filled with choices of activity for all ages and abilities.
- Optimise the site's potential by replacing 630 existing homes with almost 2,100 new homes.
- Prioritise existing Grahame Park secure tenants and those on social housing waiting list by delivering affordable housing first.
- Make up for lost time by delivering at least 1,000 new homes within the next 10 years.







Description of Development

The description of the Proposed Development is:

Hybrid planning application for the demolition of 630 residential units and existing commercial, retail and community floorspace, and the phased redevelopment of Plots 10-12 of Grahame Park comprising a full planning application for the redevelopment of Plot A and an outline planning application for the redevelopment of Plots B to Q for up to 2,088 residential units and up to 5,950sqm (GEA) of flexible non-residential floorspace.

Full planning permission is sought for the demolition of 113 existing homes and the redevelopment of Plot A comprising the erection of 5 buildings between 3 and 11 storeys to provide 209 new homes and 440sqm (GEA) of non-residential floorspace (Use Class A1, A2, A3, B1), landscape, public open space and public realm, associated car parking, cycle spaces and other associated works.

Outline planning permission (scale, layout, landscaping and appearance reserved) for the demolition of 517 existing residential units, buildings and structures on Plots B to Q, and the redevelopment of the site in a series of phases to provide up to 1,879 new homes and up to 5,510 sqm (GEA) of non-residential floorspace within classes A1, A2, A3, A4, B1, D1 and D2 including a community centre and children's day nursery in buildings ranging in height from 3 storeys to 15 storeys, with associated public open space, hard and soft landscaping, public realm, car parking spaces, and cycle parking spaces, stopping up and diversion of Lanacre Avenue and associated works.

	Preface			Design Process			Design Proposals			Access	
	Overview	ii	3.0 Involvement	11	5.0 Configuration and compliance	25	8.0 Site access and servicing	101			
	Approach	ii	3.1 Stakeholder engagement	12	5.1 Layout	26	8.1 Pedestrian access and circulation	102			
	Description of Development	ii	3.2 Design evolution	13	5.2 Amount	30	8.2 Cycle access and parking	103			
	Contents	iii			5.3 External amenity strategy	32	8.3 Vehicular access and parking	104			
	Executive Summary	iv	4.0 Design strategy	15	5.4 Residential design quality	34	8.4 Servicing and emergency access	106			
			4.1 Design proposal	16	5.5 Design compliance	38					
	Introduction and Assessment		4.2 An integrated design approach	17	5.6 Inclusive design	40		Appendix			
1.0 Introduction	1		4.3 Massing and scale	18	5.7 Communal spaces and access routes	41	9.0 Appendix	107			
1.1 Vision	2		4.4 Use	19	5.8 Approved Document M4(2) compliance	43	9.1 Scope of documentation:				
1.2 The planning application	2		4.5 Residential floorplate configuration	21	5.9 Approved Document M4(3) compliance	44	Detailed Component application drawings	108			
1.3 Structure of the document	2		4.6 Environmental design	23							
1.4 Scope of this report: the Detailed Component	3		4.7 Sustainability	24	6.0 External appearance	47					
					6.1 Building articulation	48					
2.0 Assessment	5				6.2 Existing context	50					
2.1 Site location and context	6				6.3 Design Guidelines	50					
2.2 Site assessment	8				6.4 Material palette	51					
2.3 Design drivers	10				6.5 Brick composition	52					
					6.6 Plinth	54					
					6.7 Balcony treatment	60					
					6.8 Facade composition	62					
					6.9 Metalwork	68					
					6.10 Proposed elevations	70					
					6.11 Overall appearance	74					
					7.0 Landscape design	77					
					7.1 Introduction	78					
					7.2 Landscape context	79					
					7.3 Existing context	80					
					7.4 Site wide strategy	81					
					7.5 Ground floor	82					
					7.6 Edge treatment - residential	84					
					7.7 Residential amenity	86					
					7.8 Hard landscape	89					
					7.9 First floor	90					
					7.10 Play strategy	92					
					7.11 Planting strategy	93					
					7.12 Lighting and street furniture	95					
					7.13 Ecology strategy	96					
					7.14 Water management strategy	97					
					7.15 Designing out crime	98					
					7.16 Landscape implementation strategy	99					
					7.17 Landscape management strategy	99					

Executive summary

The masterplan

The regeneration of the Grahame Park Estate is a significant opportunity to deliver on the potential of this large residential site, and to rebuild an urban community around green streets and open spaces, and with key infrastructure improvements.

The Proposed Development, located within the Borough of Barnet, will be a residential-led development as identified in the Colindale Area Action Plan and the framework of the Grahame Park Strategic Planning Document. Comprising one of several strategic sites in Colindale, and the largest extant housing Estate in the borough, it will provide much-needed new homes and a revitalised public park at its heart.

Recognising the role of Estate regeneration at a London level, the proposals balance density with openness and greenery, transforming the Estate into a new place, stitched into its surroundings to wider benefit.

The Applicant proposes an attractive, well connected, sustainable place for people to live, work and socialise helping to regenerate the surrounding area and create a step-change in the perception of Grahame Park.

The combination of new homes, commercial uses, community uses and public spaces will make this an important place within the local area. It will support a wide variety of activities, sports and cultural events, and will draw upon local history to contribute to a sense of place and identity.

The massing and architectural detail of the buildings have been developed in relation to the public realm. Specific building typologies contribute to the experience of the public spaces and each address a specific setting, whether it be defining the park edge and making the most of views over landscape, defining the different hierarchy of streets, establishing a varied skyline, or marking key space within the masterplan. Together with the public spaces, the typologies will create a unique place to live.

Detailed Component

The first phase of the development of Grahame Park will deliver a new building - Plot A - located to the northwest of the development site within the Supplementary Planning Document (SPD) designated Plot 10.

This Plot will be in close proximity to Heybourne Park and deliver 209 affordable homes and a commercial space which will benefit the new residents as well as existing communities in the surrounding area.

The proposals for the detailed component embody the principles set out for the masterplan:

- Creating clear connections;
- Different characters across the site;
- A network of streets and spaces;
- A sense of identity and place;
- A choice of different homes;
- Greener surroundings;
- Designing for daylight and views;
- Public & private areas;
- Strong relationships between buildings; and
- Feel home before reaching your door.

Throughout the design process the project team's vision has been to deliver a building capable of defining a benchmark of quality for the masterplan, a robust and carefully considered architectural response to the various demands of the site.

The design of the public realm has been central to this approach, ensuring that the new development stitches in positively with its surroundings and uplifts the quality of the existing streets to create a new and attractive destination.

- Application boundary for the Outline component of the Hybrid Planning Application
- ▭ Application boundary for the Plot A element of the Detailed component of the Hybrid Planning Application

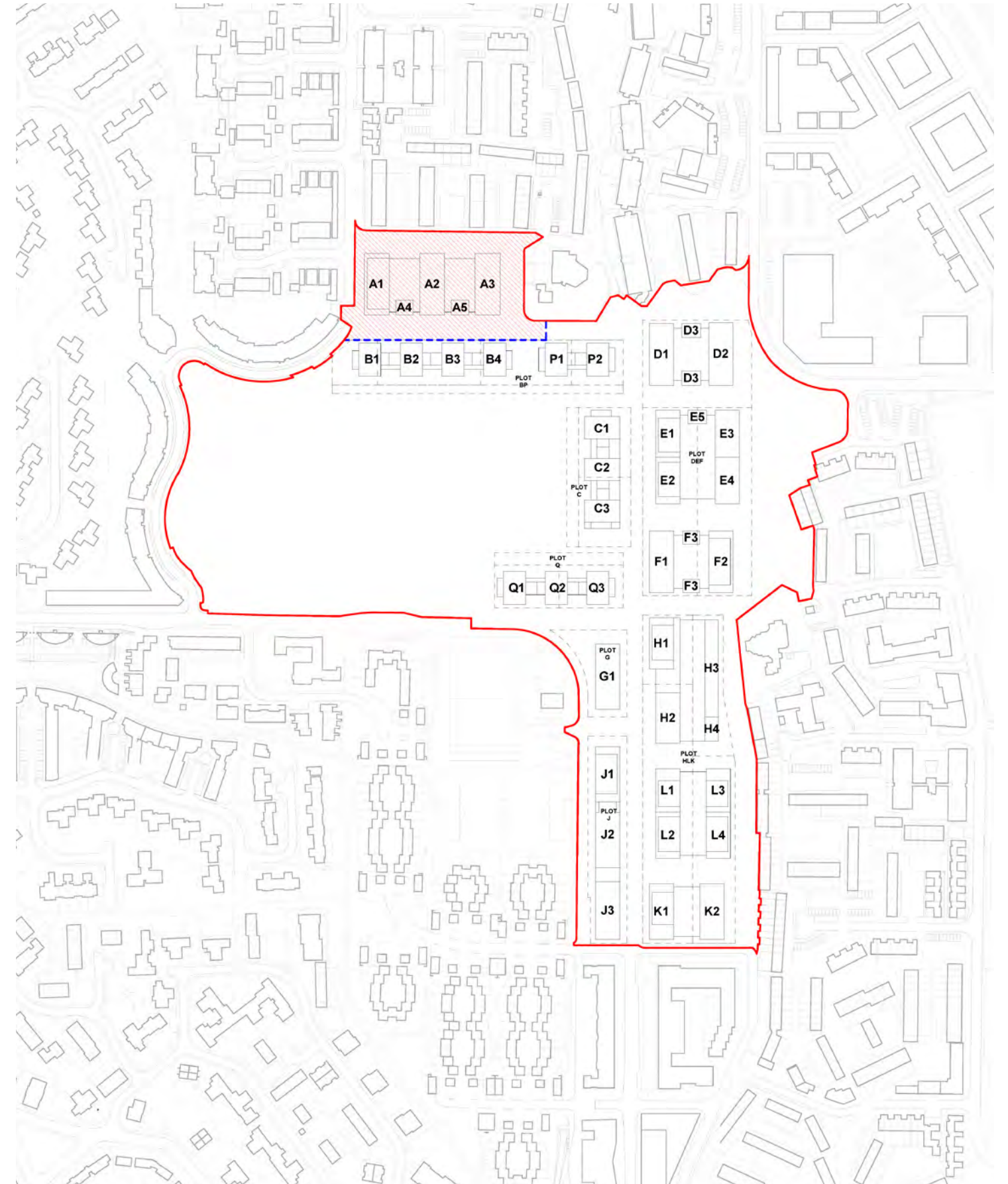

Figure 0.1: Phase 1 location plan



1.0 Introduction

1.1 Vision

Our vision for Grahame Park is to transform the existing estate into a new thriving neighbourhood. The detailed component will be the first step towards the creation of a new place, a family friendly destination that is open, innovative and capable of positively support and extend the existing community.

1.2 The planning application

The Applicant is submitting a **Hybrid Planning Application** for Grahame Park Stage B Plots A:Q (henceforth also referred to as ‘the development’ or ‘Grahame Park development’) with **Detailed** designs provided for the first phase and **Outline** designs provided for the remainder, with a number of technical and design matters reserved for latter consideration.

The application comprises the following:

- Demolition of existing buildings and structures;
- Detailed component of Phase 1a, comprising the development of Plot A and associated public realm. The Detailed Component seeks approval for scale, layout, appearance, access and landscaping; and
- Outline component for remaining phases comprising Plots B, C, D, E, F, G, H, J, K, L, P and Q as well as associated landscape with all matters reserved for future consideration.

The Design and Access Statement (‘DAS’) is divided into two volumes:

- Volume I: Illustrative masterplan, landscape design and site wide land uses; and
- Volume II (this volume): Details of Plot A (Detailed component), associated landscape and access.

This document is to be read in conjunction with the following documents also submitted as part of this planning application:

- Design and Access Statement Volume I;
- Design Guidelines;
- Parameter Plans and illustrative material; and
- Detailed Component Application Drawings.

The **Planning Statement and Development Specification** list the full suite of documents submitted as part of this application.

1.3 Structure of the document

The Design and Access Statement (DAS) has been prepared having regard to national legislation, Government guidance entitled ‘Guidance on Information Requirements Validation’ (2010), guidance published by the Commission for Architecture and Built Environment (**CABE**) and London Borough of Barnet (**LBB**)’s validation requirements.

The DAS contains the following information.

Introduction and assessment

Describes the assessment of the existing site and key strategic drivers.

Design process

Describes the design principles behind our proposals for the Detailed Component and how these were informed by the involvement with the community and other stakeholders.

Design proposals

Detailed description of the proposals including:

- Configuration and compliance: Description of the layout of the proposals and how it will work and fit with its surroundings, amount of development, residential design quality and compliance;
- External appearance: description of how the building and the place will look like.
- Landscape design: description of the public realm strategy, treatment of outdoor spaces and boundary conditions including soft and hard materials as well as planting.

Access

Description of the pedestrian, cycle and vehicular routes around the site and access points for both residents and visitors.

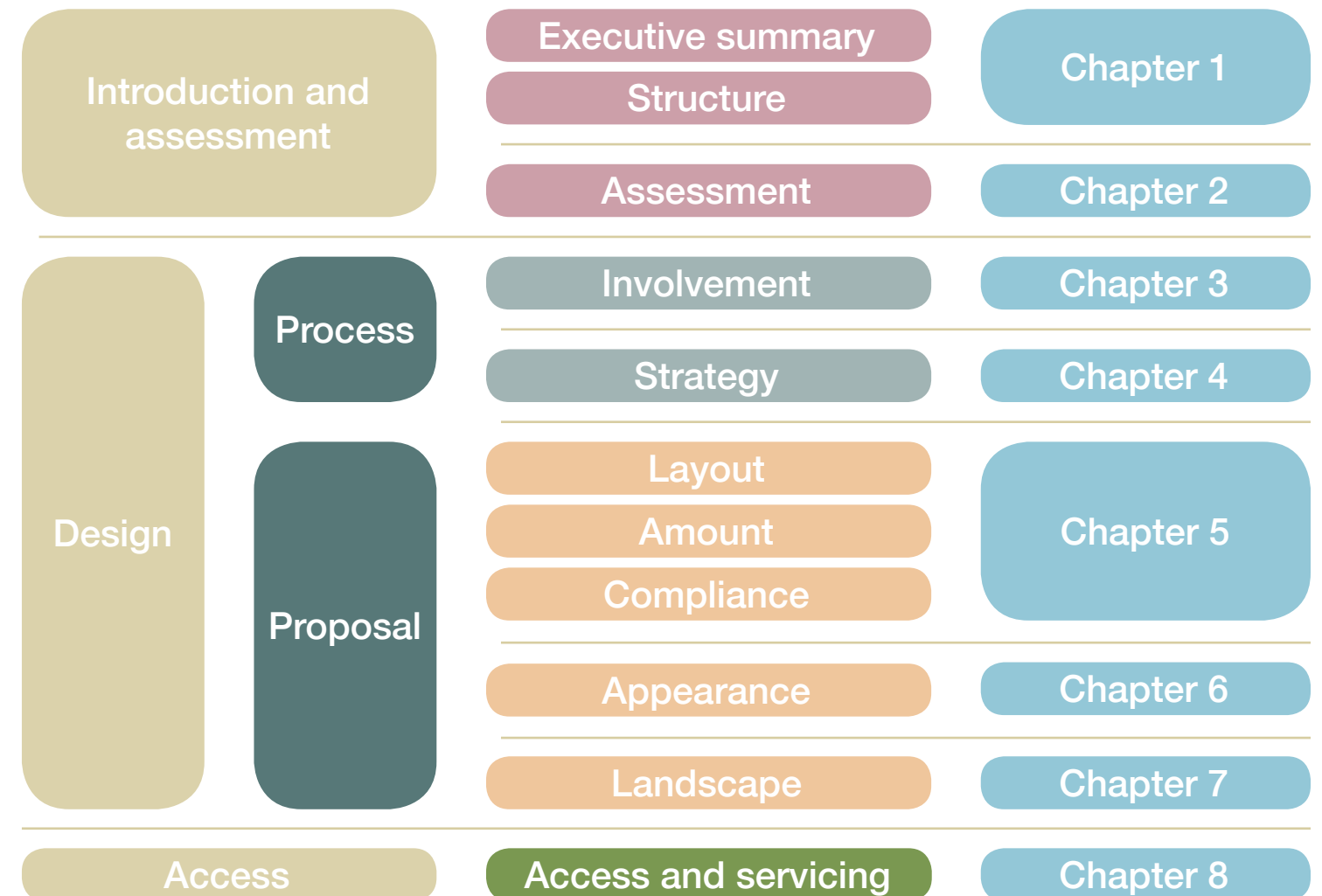

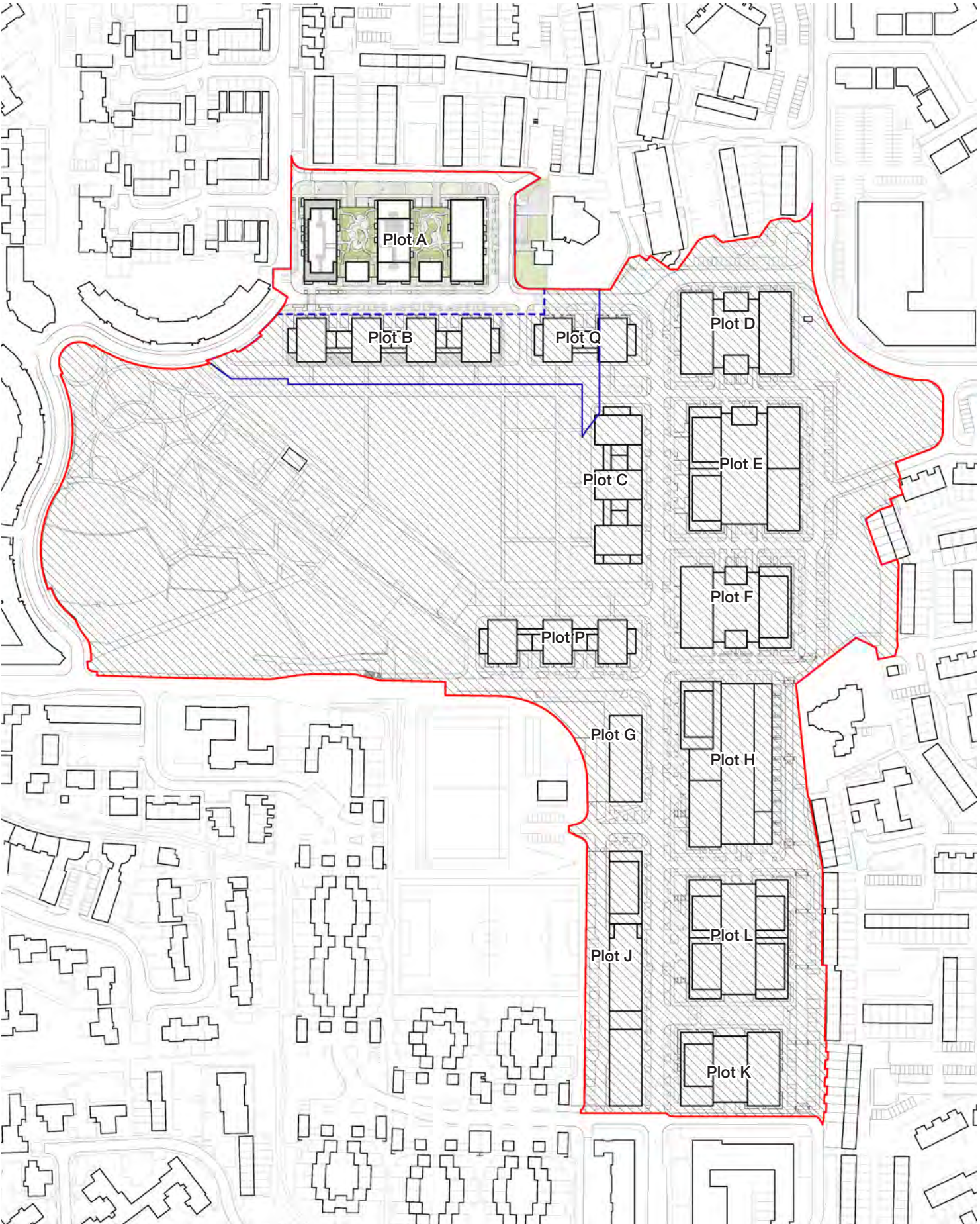
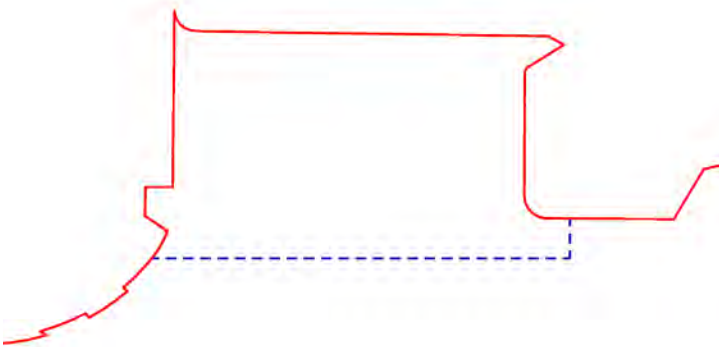
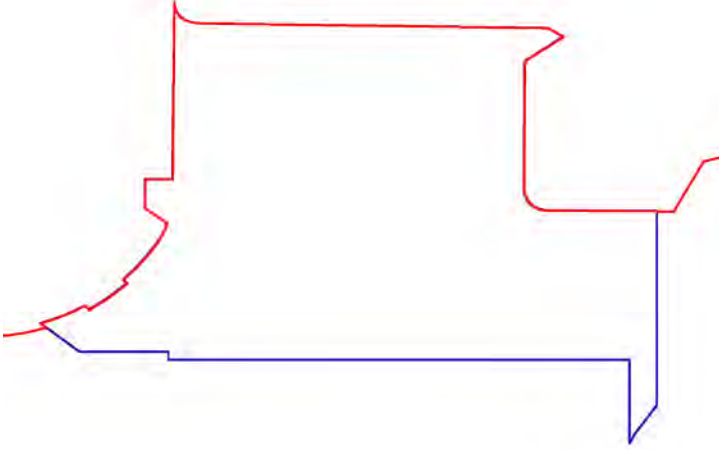





Figure 1.1: Components of the application as proposed



Extent of Plot A within the masterplan



Extent of the Detailed Component to include temporary and permanent works to landscaping and infrastructure outside Plot A

-  Outline component of the Hybrid Planning Application
-  Application boundary for the Outline component of the Hybrid Planning Application
-  Application boundary for the Phase 01 element of the Detailed component of the Hybrid Planning Application
-  Application boundary for the Plot A element of the Detailed component of the Hybrid Planning Application

1.4 Scope of this report: the Detailed Component

The Detailed Component of the Hybrid Planning Application sits within the first phase of construction and includes the delivery of Plot A and associated public realm.

The first phase will comprise the area currently occupied by a series of residential buildings named Nisbet and Noel, located to the north of Heybourne Park and the existing Nimrod, Nicholson and Nighthawk blocks. The Site is directly to the west of St Augustine’s Church and is surrounded by existing residential properties to the north and west sides.

Plot A will deliver a total of 209 affordable homes divided into five blocks as well as two residential courtyard gardens at first floor level. The new homes will be delivered in a variety of sizes and configurations ranging from 1-bedroom apartments to 5-bedroom 3-storey houses.

Plot A will provide homes to rehouse all of the secure social tenants within the outline application site (SPD Plots 10-12), up-fronting the delivery of Social Rent homes to ensure that secure residents move only once throughout the duration of the regeneration works.

Plot A will also provide a commercial space and a new energy centre with potential to serve adjacent buildings within the new masterplan.

BLANK PAGE

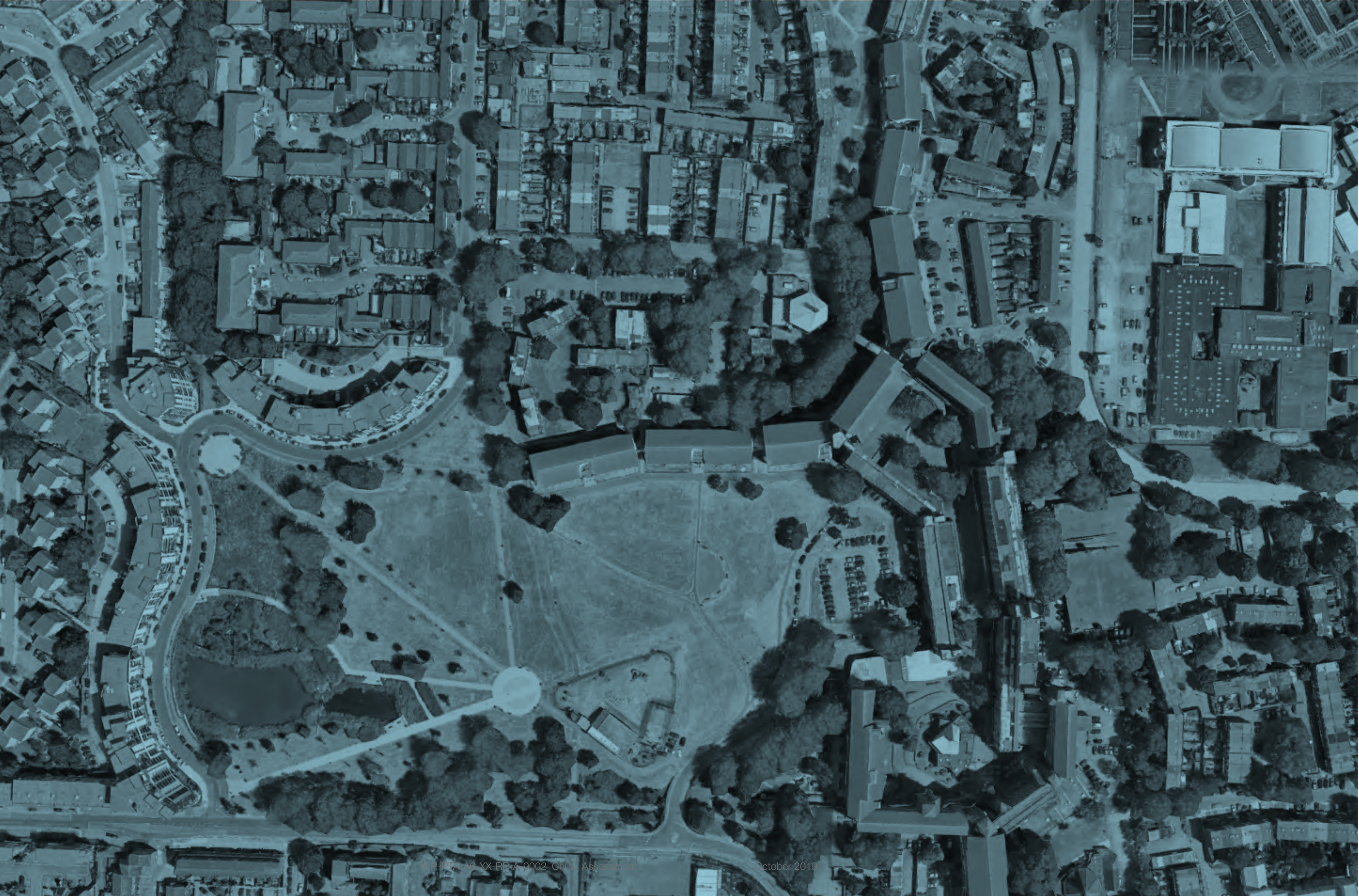

2.0 Assessment

2.1 Site location and context

Located on the northwest corner of the masterplan, the Site for the Detailed Component is bounded on three sides by existing streets: Heybourne Crescent and Clayton Field to the west and Great Field to the north and east sides. With a total area of 10,037sq.m (1 Hectare), the site is currently occupied by an assembly of residential buildings belonging to the Grahame Park Estate, typically 2 storeys high, and two rows of garages.

The Site is predominantly surrounded by residential buildings in a mix of low-rise terrace houses and apartment blocks. The buildings immediately to the north are 2-storey terraced properties facing east and west with blind flank walls facing the development site. All private gardens adjacent to **Great Field** road are delimited by brickwork walls approximately 1.6m tall, so there is little visual permeability to these properties (Fig. 2.8).

To the west of the site is **the regeneration Stage A Heybourne Crescent**, a residential development of 4-10 storeys with a curved footprint which delineates the west boundary of Heybourne Park.

Immediately adjacent to the site is **Douglas Bader Park**, a housing estate of 2-3 storey houses and apartment blocks which is also subject to a separate redevelopment proposal by another developer. This potential development highlights the opportunity and appetite for change in the area.

Directly to the east of the site is the existing **Saint Augustine's Church** and vicarage building. A series of existing trees line the boundary of the Church's property facing Plot A which sit outside the application boundary and will not be impacted by the proposals. The Church itself is clad in brickwork to match the rest of the Estate, angular in shape and relatively low in height (Fig. 2.4, 2.5). Behind St Augustine's is Plot 13 of the Grahame Park Estate, the closest buildings being two 4 and 6-storey apartment blocks named Norris and Orde.

A series of 4-storey apartment blocks sits to the south of the site comprising Nimrod, Nicholson and Nighthawk. These are proposed for demolition as part of the phase 1 works.

Heybourne Park is the most significant public green space and is located in close proximity to the site. In addition to this large park, which is included in the outline component of this planning application, there is a woodland area to the west of Douglas Bader which has the potential to be made more accessible in the future.

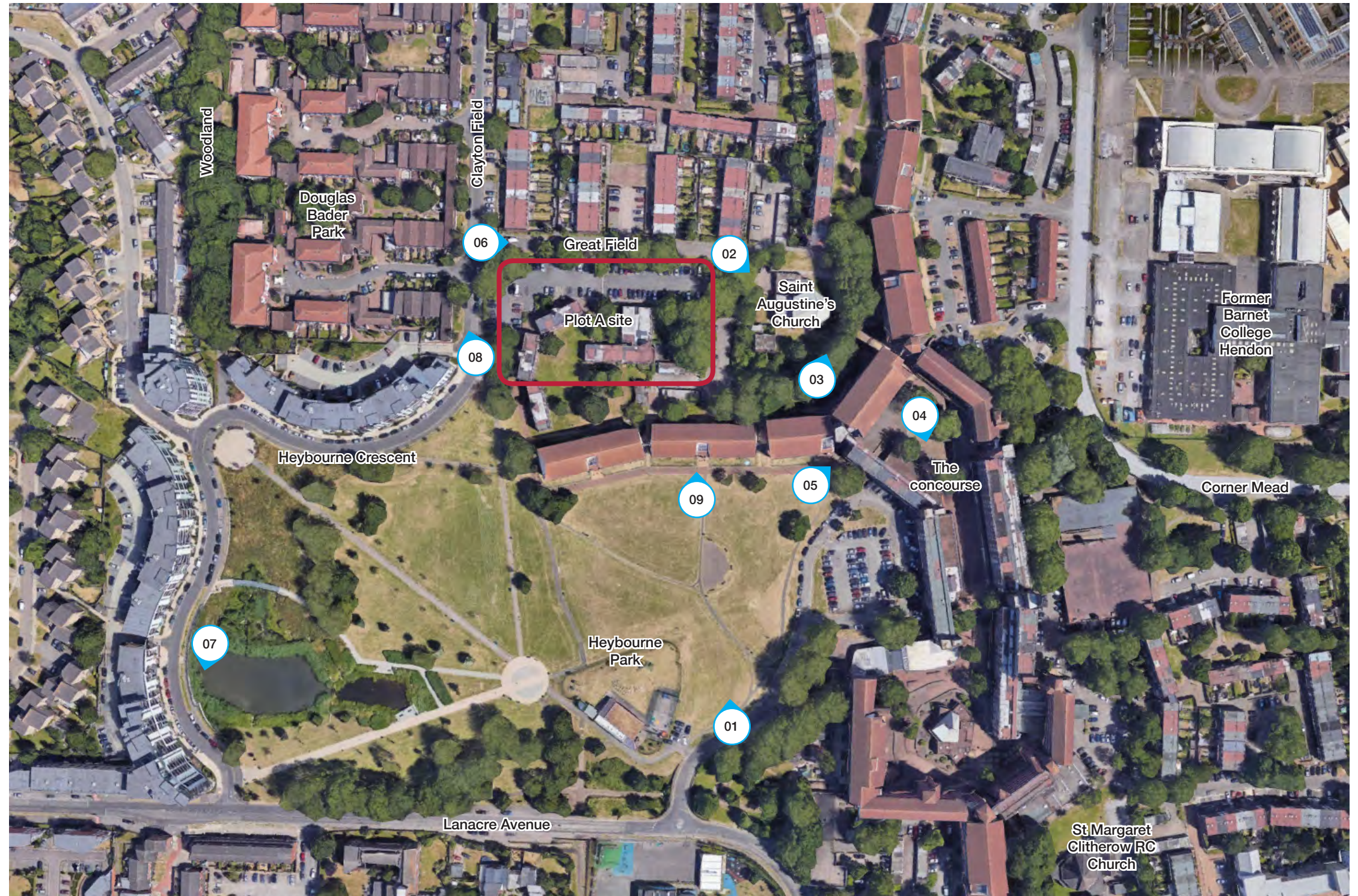

Figure 2.1: Aerial view of the Site and immediate context



Figure 2.2: Bird's eye view of surrounding building heights



Figure 2.3: View from Heybourne Park looking north towards Nimrod, Nicholson and Nighthawk



Figure 2.4: Saint Augustine's Church (west side)



Figure 2.5: Saint Augustine's Church (east side), Norris and Orde

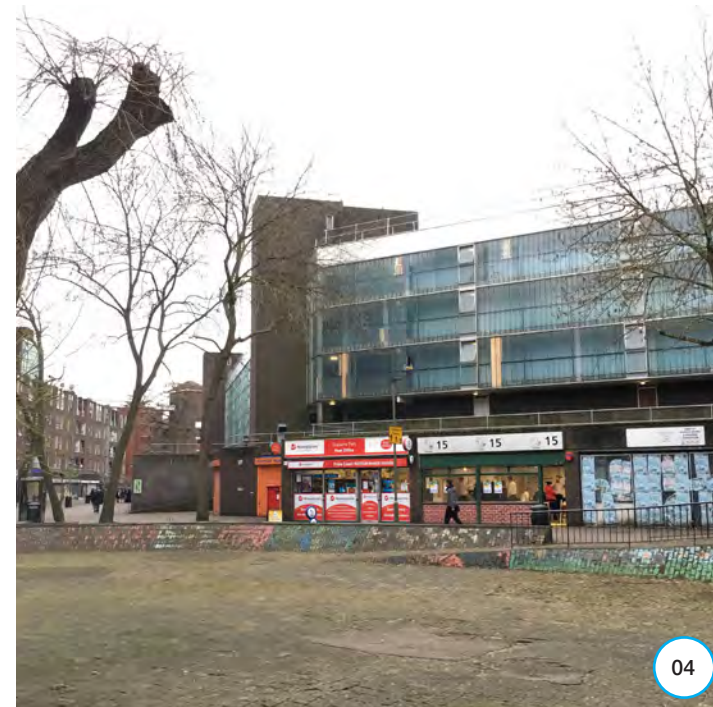

Figure 2.6: The concourse

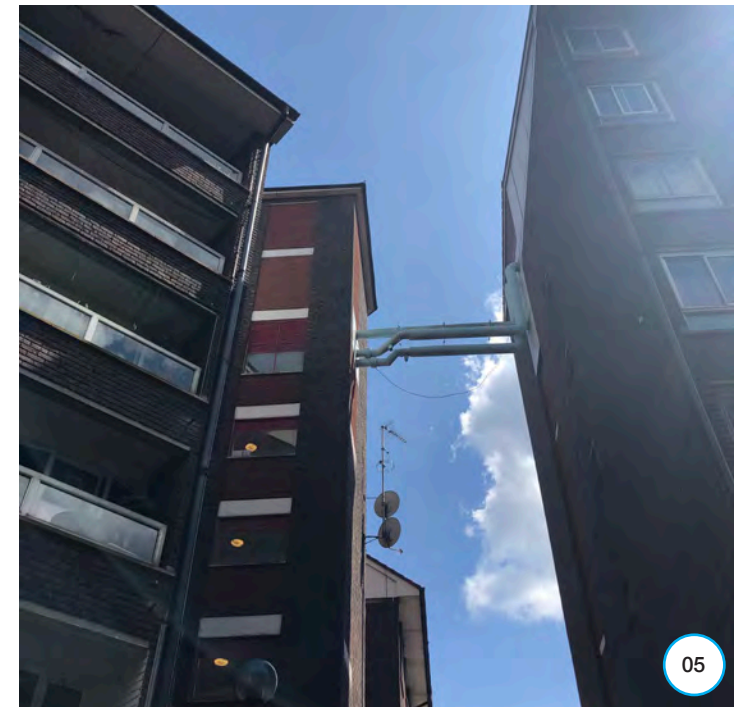

Figure 2.7: Existing Grahame Park Estate: high level servicing



Figure 2.8: View of Great Field Road, Plot A site to the right hand side



Figure 2.9: Heybourne Crescent



Figure 2.10: Douglas Bader estate

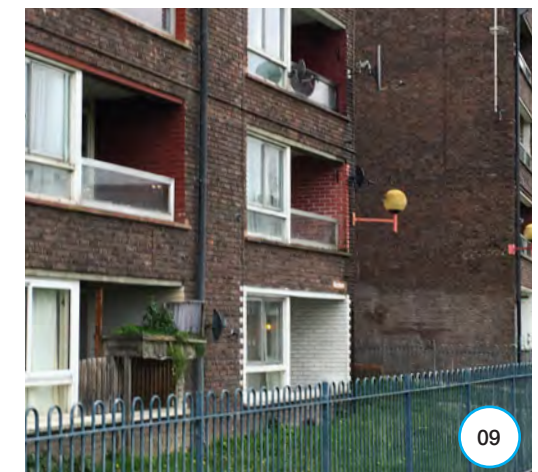

Figure 2.11: Existing Grahame Park Estate (Nicholson)

2.0 Assessment

2.2 Site assessment

The existing site for Plot A follows the same principles that shape the wider Grahame Park Estate, namely the clear physical separation between vehicular and pedestrian routes characteristic of the Radburn layouts. An open car park occupies a large portion of the site, with existing Great Field terminating on a dead-end that serves a row of garages. This segregation contributes to the 'inward looking' character of the existing estate, lack of legibility of the street network and generally uninviting feel of the built environment.

The development proposals seek to re-establish a traditional hierarchy of streets and reconnect the site with the surrounding network of streets and open spaces. A new east:west street will be created south of the plot and expressed as the main route to eventually join into Bristol Avenue and Corner Mead to become one of the main arteries of the masterplan: **Nighthawk Road**. Great Field will be reconfigured to replace its dead-end condition with a circular route.

The demolition of the apartment blocks to the south of the site (Nimrod, Nicholson, Nighthawk) provides the opportunity to reconfigure the relationship with **Heybourne Park**. To strengthen this proximity, a point of access to the park is provided at the end of Great Field road creating a strong connection between the Park, the new plot and the Church.

During the first phase of development pedestrian access to the existing bus at **Quakers Course** will be maintained, as well as access to the various shops and services within the **Concourse**.

Surrounded on three sides by existing roads, the site presents a difference of level of 820mm between the ground floor level on the west side (lower) and east side (higher). This constraint is used to our advantage as it allows for the west side to have a taller ground floor height while reducing the ground floor height on the east side in proximity to the Church.

Due to its location and context, the first phase of the regeneration project will play a fundamental role in repairing the Estate edges while integrating the new development into the surrounding context. While doing so it will define a new entry point into the site from Heybourne Crescent, and a new gateway into Heybourne Park for those arriving from the north down **Clayton Field**. Together with Douglas Bader, the new buildings will frame and redefine views into the Park.

- Masterplan application boundary
- Phase 1 application boundary
- - - Plot A application boundary
- Location of Plot A
- Main route
- - - → Secondary route
- · · · · → Tertiary route
- - - → Access to Heybourne Park
- Heybourne Park
- ↓ ↓ ↓ ↓ ↓ ↓ ↓ ↓ Park frontage
- Secondary facade
- Hard frontage
- Pedestrian area
- Parking area
- Temporary landscaping / site compound
- B Bus stop

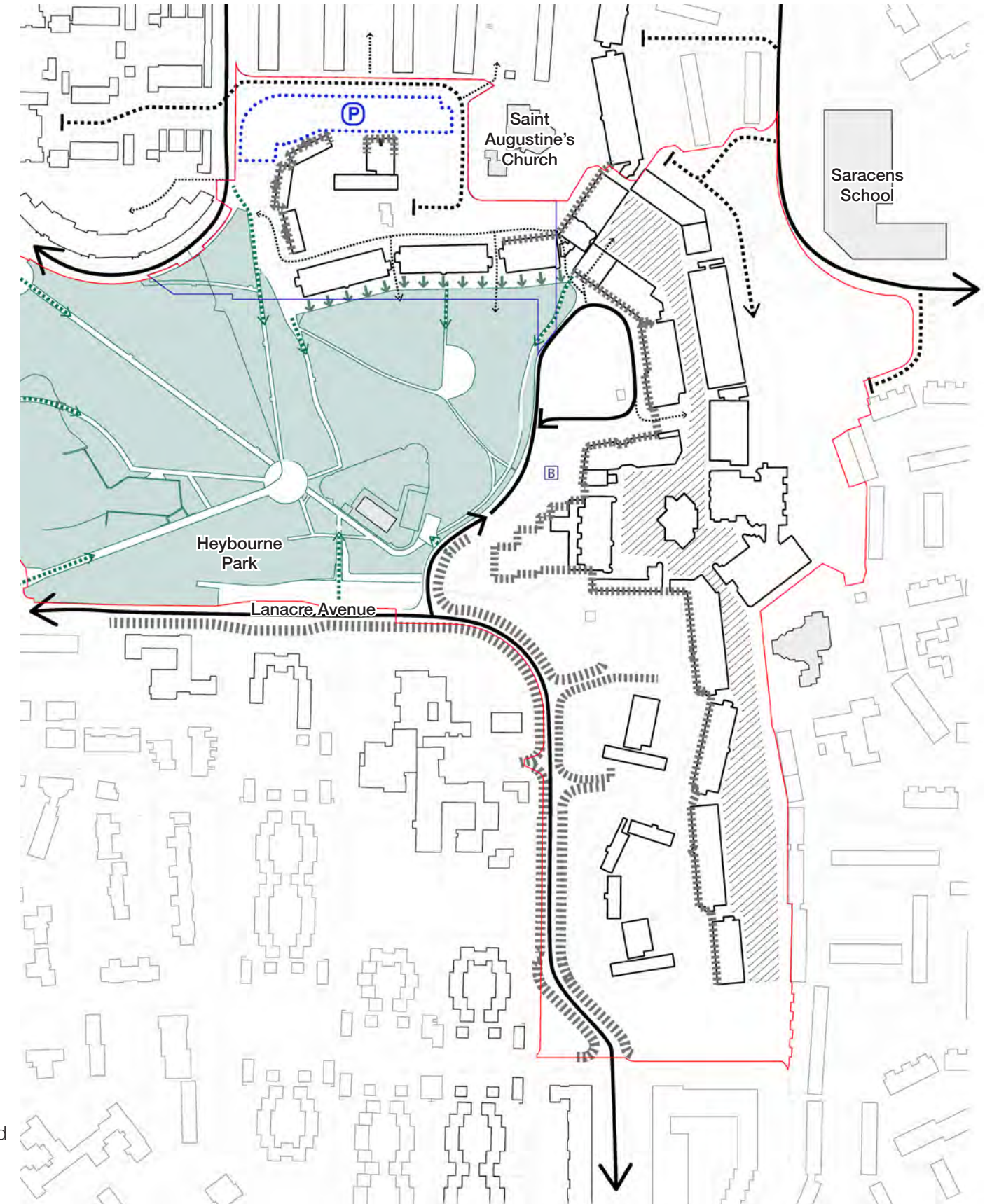

Figure 2.12: Existing site: access diagram

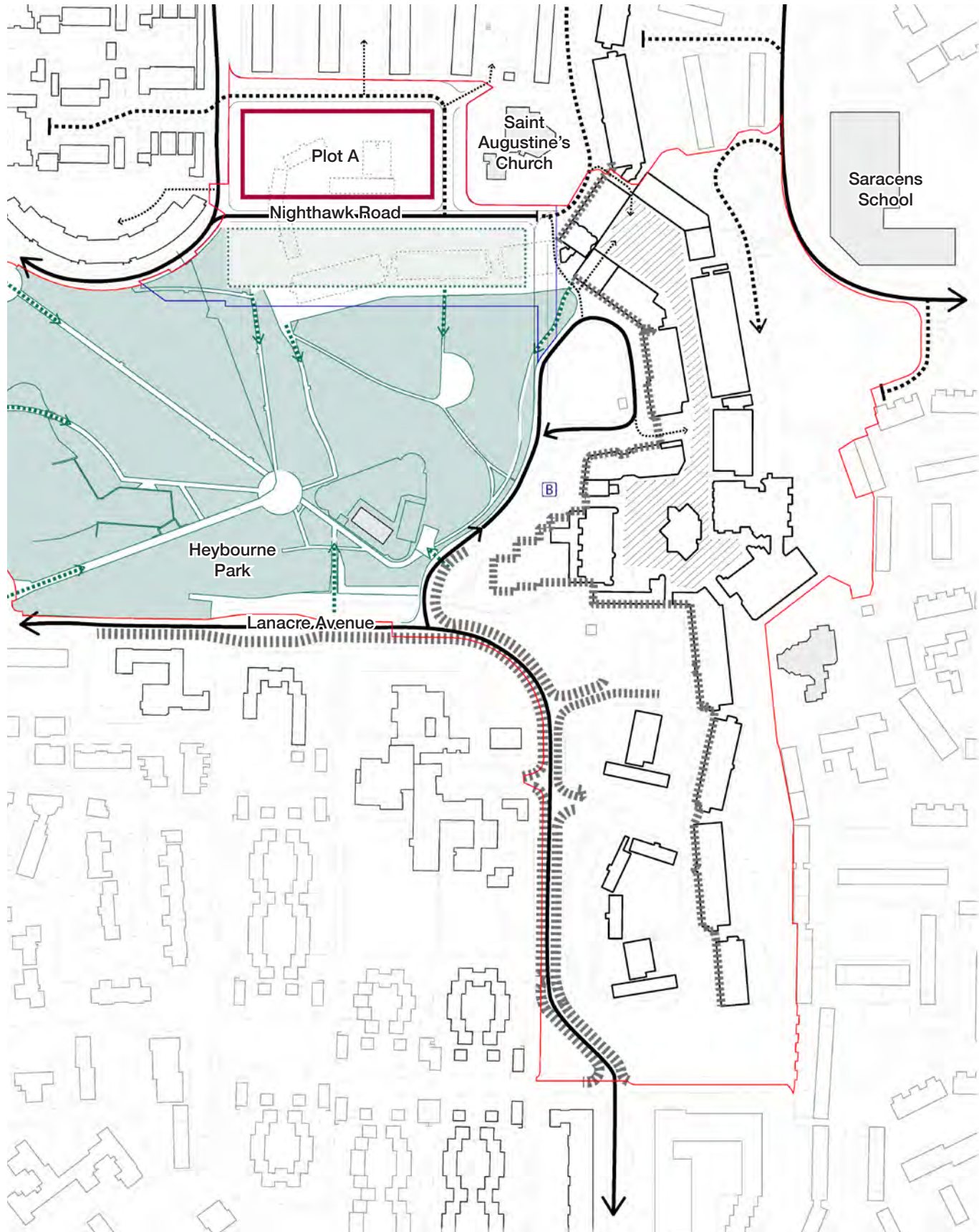

Figure 2.13: Phase 1a: access diagram

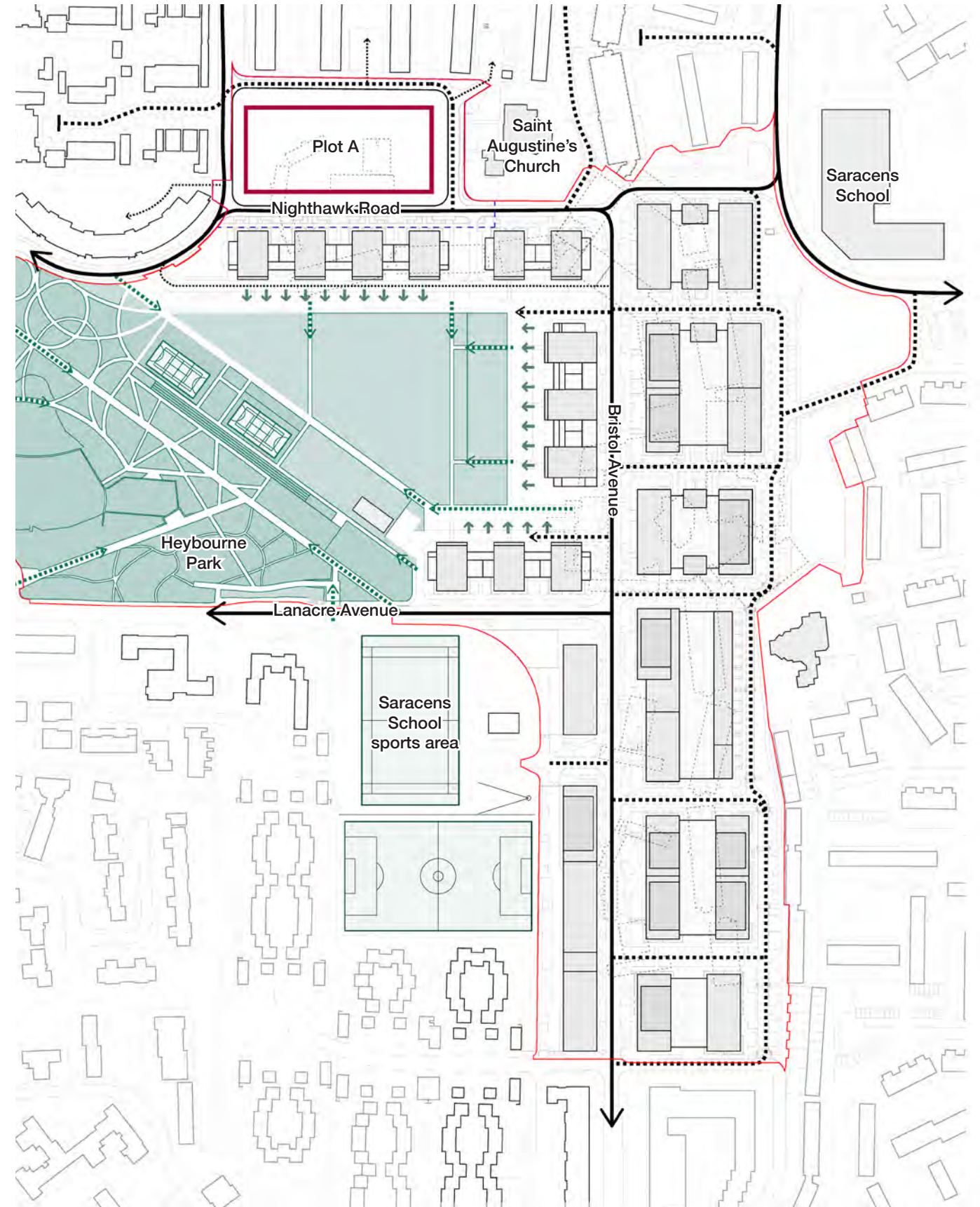

Figure 2.14: Proposed Masterplan: access diagram

2.0 Assessment

2.3 Design drivers

Plot A has been developed to follow the key principles derived from the masterplan:

Increase proximity to green spaces

Achieved by creating two direct access points into Heybourne Park as well as designing both Plots A and B to allow for visual links to the Park from Plot A.

Create a clear network of streets

Achieved by improving legibility and connectivity. Nighthawk Road (south street) is designed as the main route and Great Field as a secondary one-way road with narrower carriageway width and slower traffic.

Respond to context

Achieved by adjusting the position of the road between Plot A and Saint Augustine's Church and providing a generous distance between the building and the Church boundary. This reduces the impact of the new building volume on the Church's setting while allowing greater flexibility for the potential redevelopment of Saint Augustine's site.

Maximise green spaces

Achieved by conceptually extending the park to the new development:

- Pockets of soft landscape and hedges populate the streets that surround the new plot.
- New gardens provide green spaces for residents and visual amenity to the wider community.
- Existing mature trees retained where possible.

Reinforce strategic markers

Achieved by determining prominent points that will work as wayfinding devices.

Frame the public realm

Achieved by designing the building typology to respond to its setting, following the overriding principle of the masterplan townscape strategy: the building façades interact across the street to define the character of the public realm.

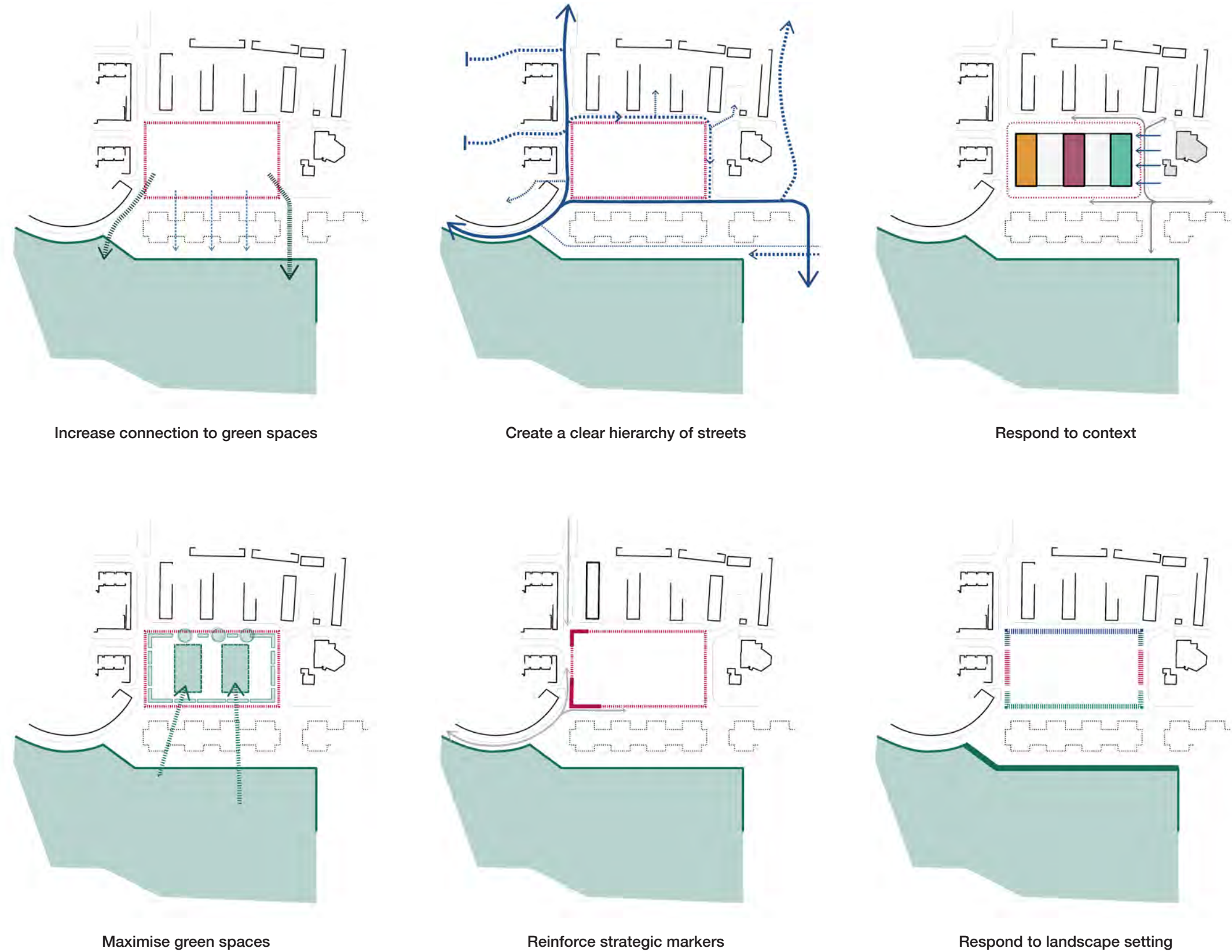

Figure 2.15: Strategic principles



3.0 Involvement

3.1 Stakeholder engagement

The proposals for both the masterplan and detailed component have been subject to analysis and consultation with a number of different stakeholders:

- Public Consultation events:
 - 21st March 2019;
 - 23rd March 2019;
 - 16th May 2019;
 - 18th May 2019; and
 - 20th July 2019.
- London Borough of Barnet (LBB);
- Greater London Authority (GLA);
- Design Council Cabe's Review;
- Church of England - Diocese of London;
- Douglas Bader estate regeneration team;
- Briefing workshops with Colindale Community Trust and Friends of Heybourne Park;
- Transport for London (TfL); and
- Metropolitan police.

Liaison with the London Borough of Barnet and Greater London Authority was continuous throughout the development of the project. The consultations with the various stakeholders and the wider public raised issues which informed the development of the proposals.

For instance, allowing for future development of Saint Augustine's Church, the building footprint has been set back and the height reduced on the east side of the Plot.

Similarly, to address the questions regarding the character of Great Field road to the north of Plot A the team has widened the existing road to provide soft landscape zones and additional parking spaces as well as retaining existing trees wherever possible. This street was also converted to a one-way road with traffic calming measures to reduce traffic and potential noise.

A detailed analysis on the consultation with the Designing out Crime Officer (Metropolitan police) and resulting actions can be found in Chapter 7.15.

There was an expressed desire for play spaces in the area and a positive response to the additional greenery to the streets and provision of a supermarket in Plot A. Generally the proposals have been positively received in the context of the overall regeneration scheme. Further details can be found in the **Statement of Community Involvement**.



Figure 3.1: Public Consultation event on 18th May 2019



Figure 3.2: Public Consultation at the Grahame Park Festival on 20th July 2019



Figure 3.3: Boards from the Public Consultation events in March 2019

3.0 Involvement

3.2 Design evolution

Once the key design drivers for the site were established, the team explored various different options before settling for the final configuration.

Option A

The team started by considering an option which would approximately replicate the solution submitted as part of the previous planning application, with an intensification in height to provide the required amount of residential use. This option would consist on a four-sided courtyard block made up of apartment blocks to the west, east and south sides and a double stack of maisonettes facing Great Field to the north.

Whereas this typology places the lowest height on the north side and adjacent to existing low-rise buildings, it would result in the creation of a highly overshadowed courtyard due to the linear block on the south side. Additionally, in order to intensify residential provision this typology would create north facing apartments on east:west blocks.

Option B

Option B consisted of two linear blocks along the side streets with a third smaller block on the north side and a row of south facing 3-storey houses.

This option was discarded as it resulted in a significant number of single aspect north facing flats while creating a visual barrier to the existing houses to the north of Great Field, increasing the potential for overshadowing of existing homes.

Option C

This option delivers three west / east facing linear blocks with one courtyard at first floor and one courtyard at grade, in order to locate all cores centrally to the blocks.

The split of the courtyards in two levels would result in a significant loss of usable amenity area and reduce the opportunity to provide secure play spaces. Car parking in the podium would be less efficient and rely on a single access dead-end configuration.

Furthermore, whereas locating the townhouses on the north side would animate the street these would increase the potential for overlooking to the north.

Preferred option

The chosen option took the position of the linear blocks as shown in Option C, as these allow for better daylight to both the courtyards and the streets, with no north facing single aspect homes, in comparison to the other options considered. More details can be found in the next chapter.

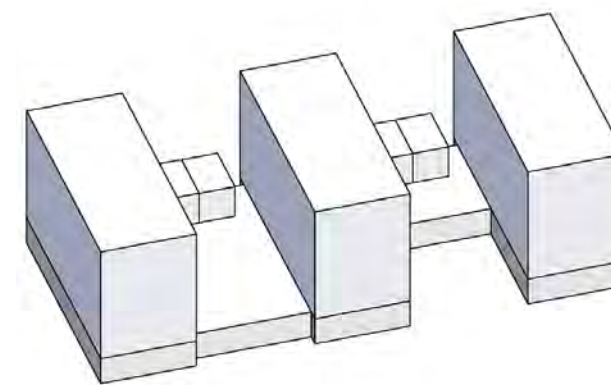
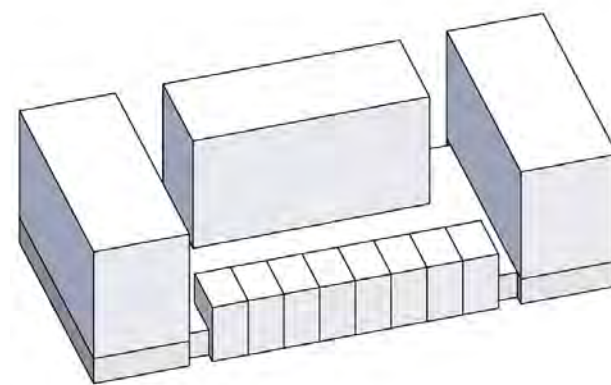
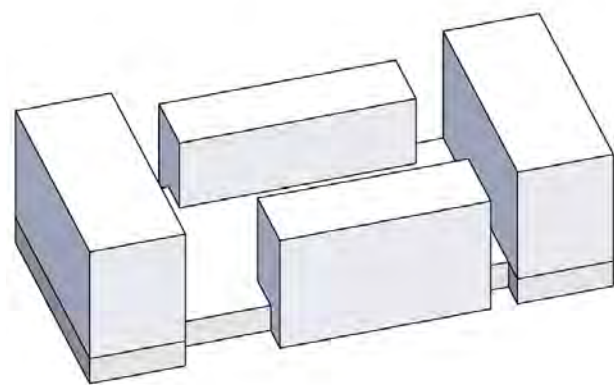
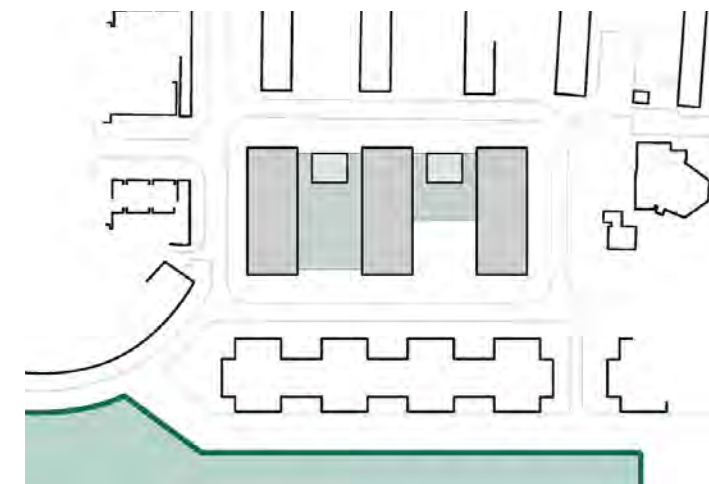
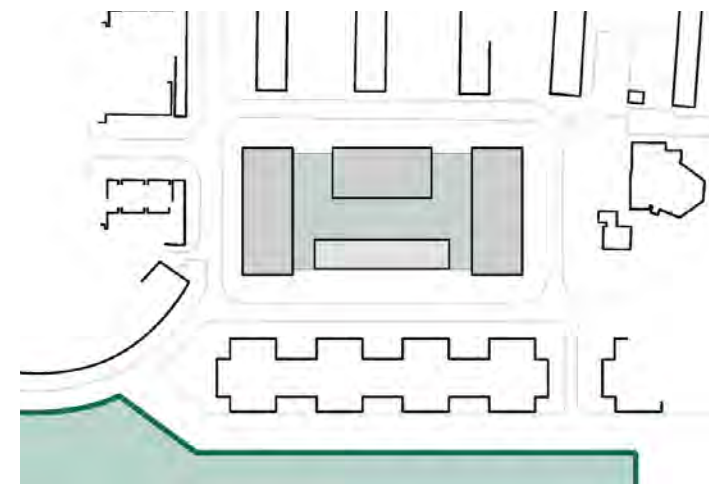
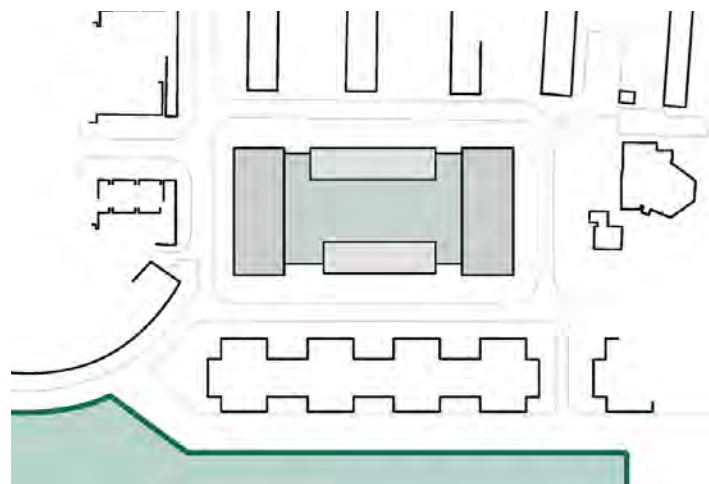
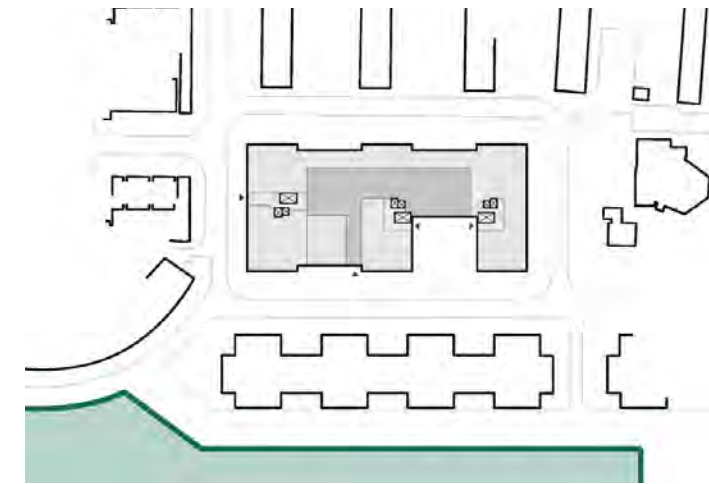
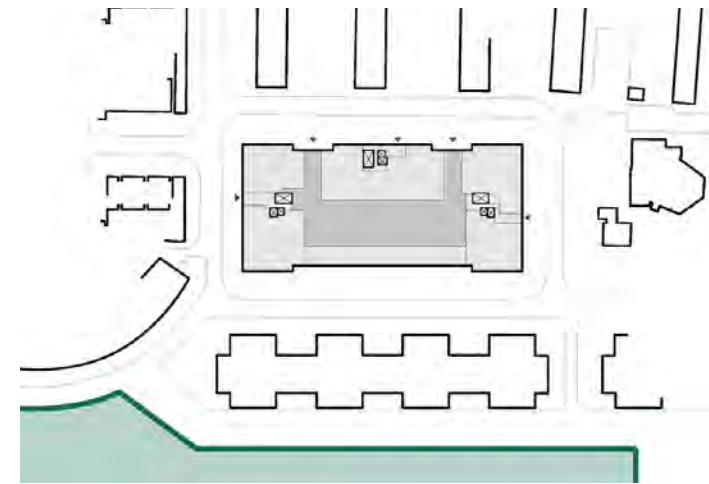
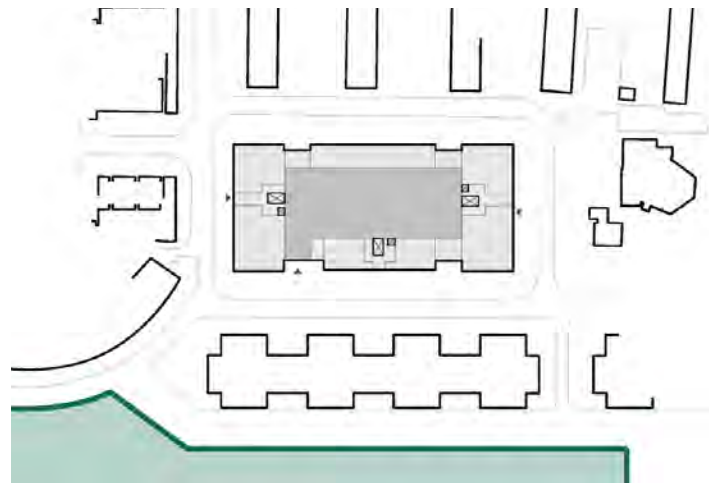
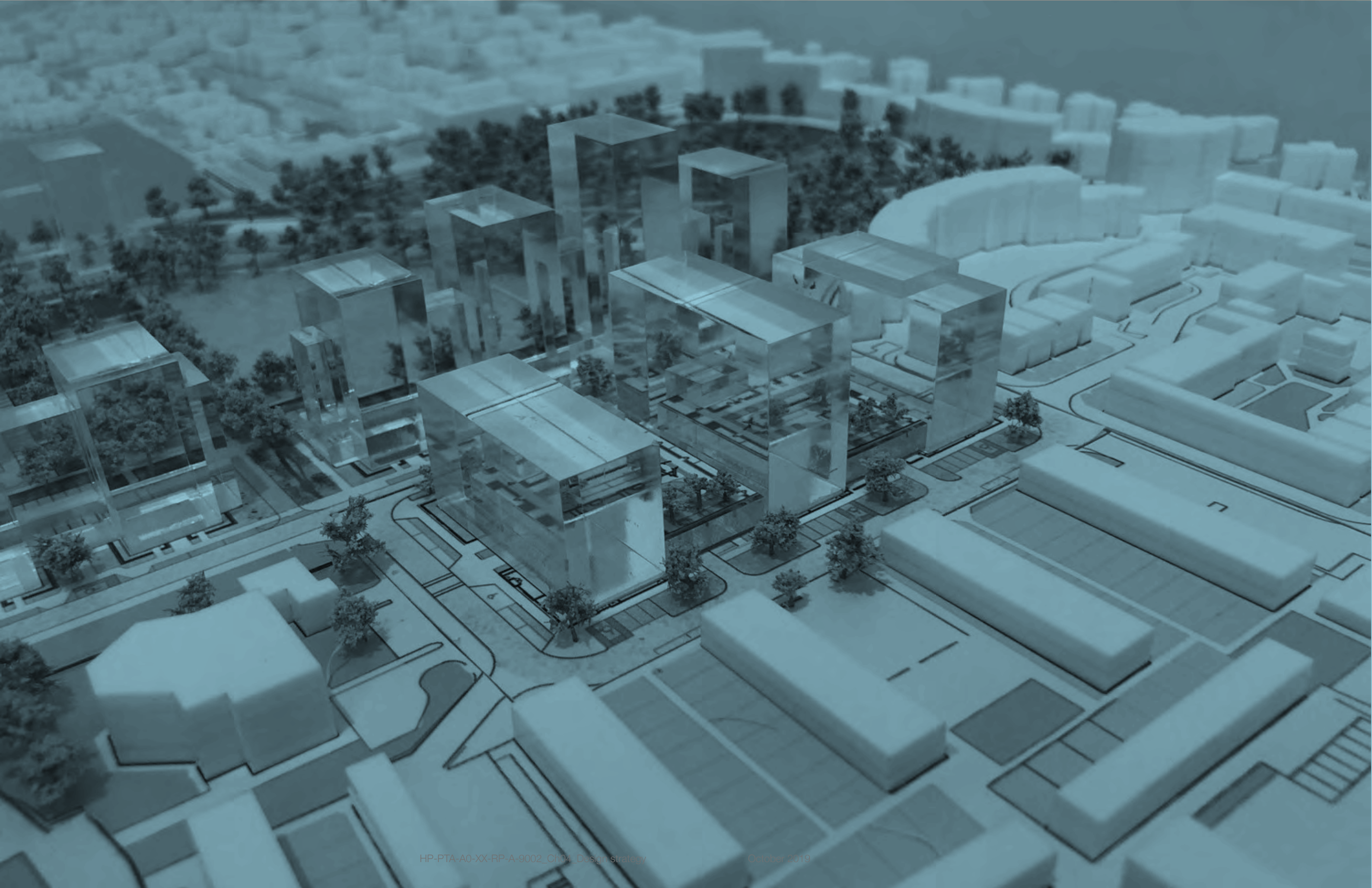

Figure 3.4: Option A: Ground floor plan, roof plan and axonometric view

Figure 3.5: Option B: Ground floor plan, roof plan and axonometric view

Figure 3.6: Option C: Ground floor plan, Roof plan and axonometric view

BLANK PAGE



4.0 Design strategy

4.1 Design proposal

The proposal put forward by Patel Taylor brings together the overarching principles of the masterplan and the careful analysis of the context and particular setting of the Plot A Site.

The first gesture of the proposal is to divide the massing volume of the Plot in separate buildings, opening up two courtyards. These will define three linear buildings oriented north:south to maximise light into the courtyards which are designed as attractive gardens for the residents to gather and enjoy.

By presenting the short end gable of the three linear buildings to the north, overlooking and overshadowing of neighbouring properties is minimised compared to the options studied in earlier configurations.

The linear volumes respond to the street setting by creating prominent building frontages facing the approach from Heybourne Crescent on one side and from Corner Mead and Saint Augustine's on the other.

The buildings are raised on a common plinth that provides car parking at grade and secure bicycle storage for residents with the courtyard gardens located at first floor. Recessing the footprint of the plinth in between the linear buildings creates the opportunity to provide double and triple aspect to the ground floor uses at the same time as creating a more articulated streetscape.

The plinth is then animated with two pairs of townhouses located on the south side between the linear blocks. These fulfil the need to provide family homes as part of the decant strategy and diversify the residential offer. The houses will be triple aspect and provided with amenity spaces at ground and first floors as well as access to the shared courtyards.

The massing of the three linear buildings is articulated in response to the surrounding context by reducing the height to the west and east volumes (A1, A3) and increasing the height at the centre of the Plot (A2).

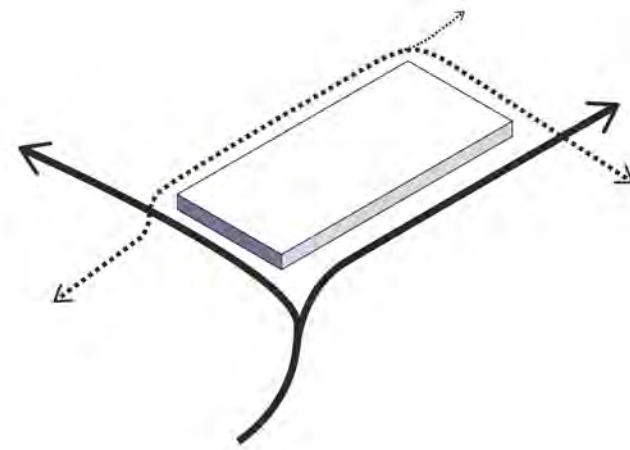

Establish the footprint and connections

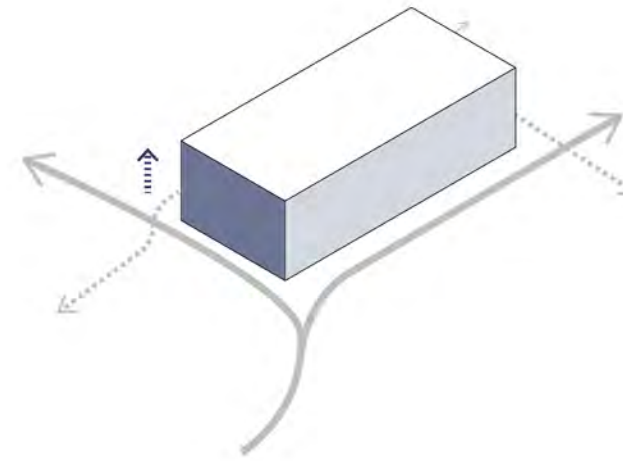

Extrude the volume

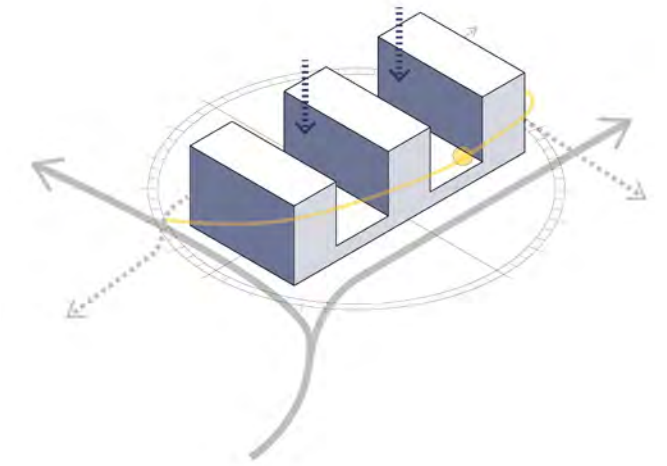

Define buildings and courtyards

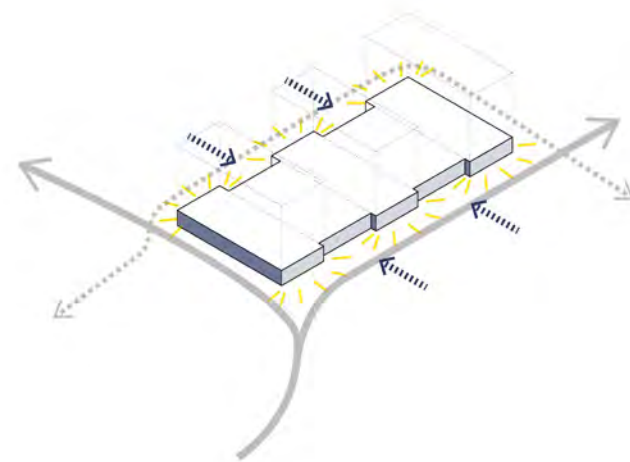

Articulate the plinth

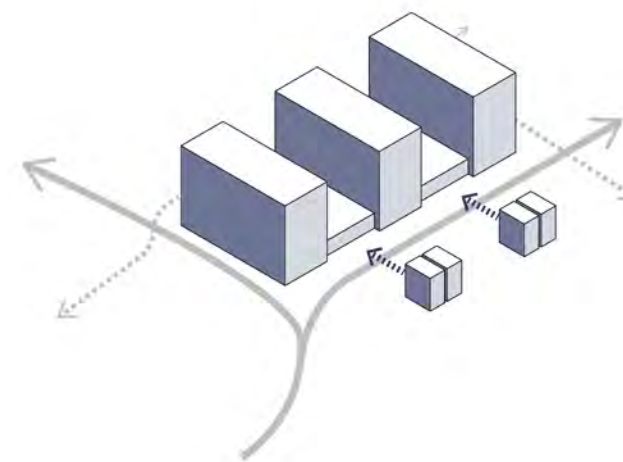

Integrate the houses

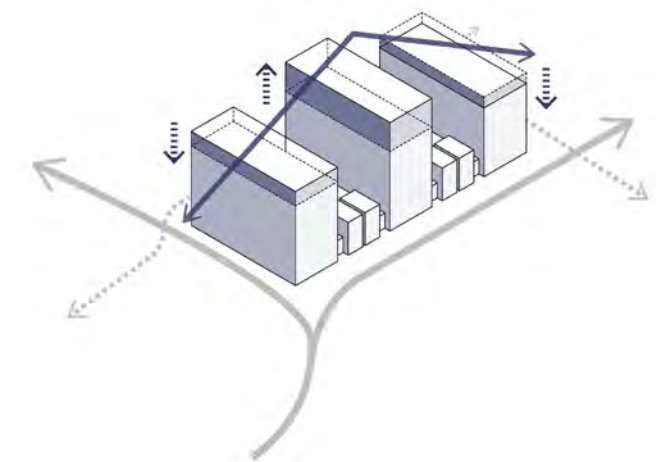

Refine the heights

Figure 4.1: Volumetric diagrams

4.2 An integrated design approach

The strategy for the first phase has been developed in conjunction with the surrounding masterplan to achieve high quality homes within inviting and successful public spaces and streets. Whereas Plot A is the first step towards the wider regeneration of this area and is designed to deliver immediate local improvements, the relationship between the first phase plot and the surrounding masterplan buildings is fundamental to achieving the long term design vision for the site.

Despite being different typologies Plots A and B have been designed to create a positive relationship between each other along the new street (Nighthawk Road) that will connect Corner Mead to Heybourne Crescent.

Plot B is a mansion block typology where the apartments are organised around a central core, creating articulated façades of vertical expression. The main volumes (pavilions) are dominant in height while the volumes in between (wings) are lower and recessed in relation to the main façades. The south end of the linear blocks in Plot A face the pavilions of the mansion blocks and are also expressed vertically, generating a dialogue across the street.

In addition to this, Plot B is placed strategically so that each of the linear buildings in Plot A can enjoy views towards either the park or the sky above the lower volumes of the mansion block's wings. This also improves daylight to the homes and courtyards of Plot A while providing a more articulated and interesting skyline.

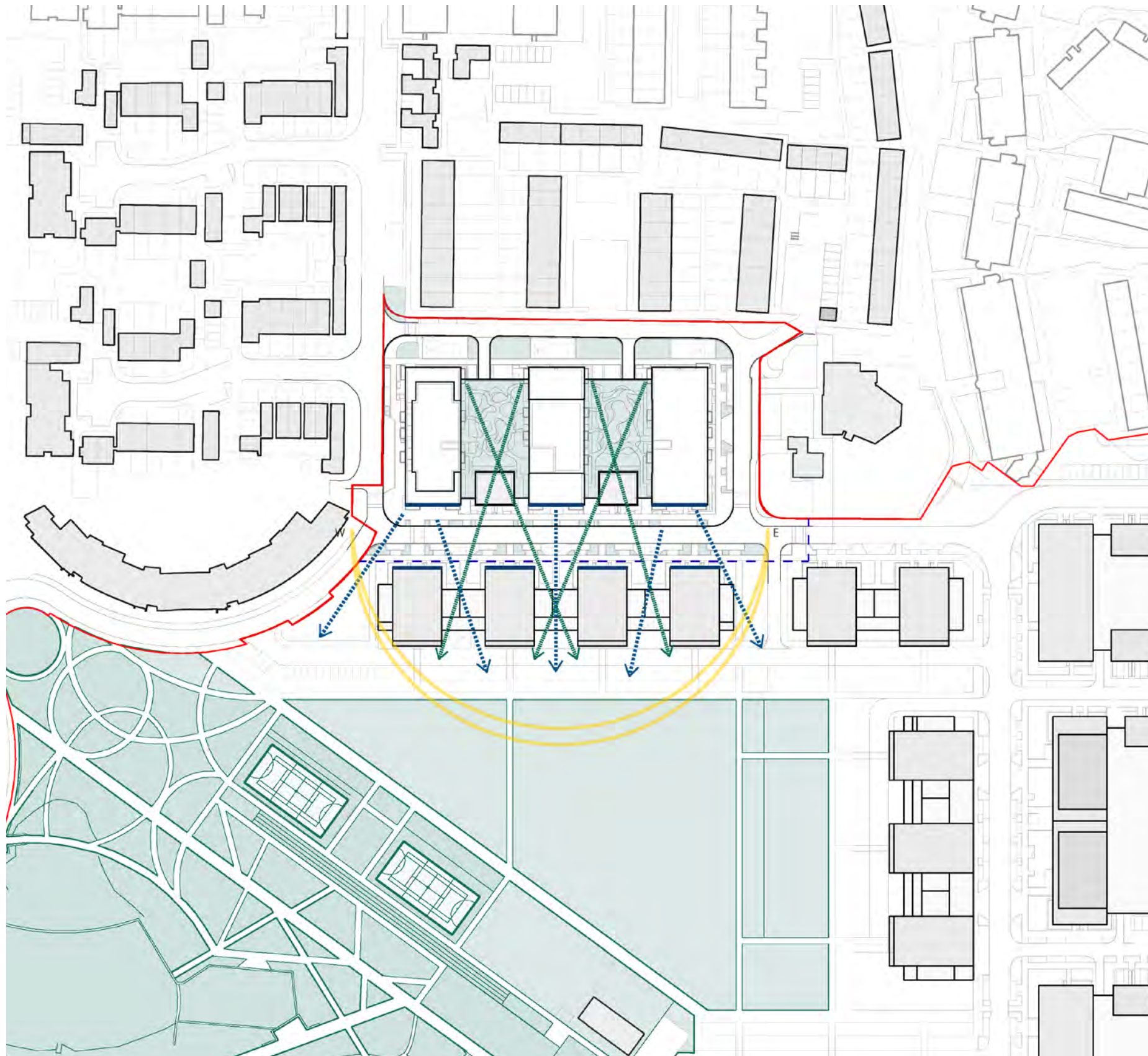

Figure 4.2: Relationship between Plot A, Plot B and Heybourne Park



4.0 Design strategy

4.3 Massing and scale

The proposed massing for Plot A has been shaped in response to its setting, the wider masterplan and the decant strategy requirements.

In the context of the overall masterplan scheme, the proposed massing gradually reduces in height from the tallest element in Plot B adjacent to Heybourne Park via Plot A towards the existing low-rise buildings to the north (Fig. 4.5).

Respecting neighbouring community use

Having established the principal height in relation to adjacent Plots, Plot A increases height to the centre block (A2) which is located away from the surrounding context so that A1 and A3 can reduce in height proportionally. A3 is the lowest of the three blocks at 6 storeys above plinth, due to the proximity of Saint Augustine's Church and 'Oxford'.

Emerging context

To the west side the existing context is slightly higher with Heybourne Crescent reaching 10 storeys at its southern end and the potential development of Douglas Bader also increasing in relation to the existing height. Despite this tendency, the proposals include a set back to the top floor of A1 on the south, west and north sides. This set-back reduces its visual impact while providing a special treatment to the top of this prominent building.

Minimising impact of district heating

As the tallest of the three blocks, A2 will house the Air Source Heat Pumps required for the energy strategy as well as the flue to the back-up boilers in the energy centre. The plant equipment will be screened on four sides by a perforated hit and miss brick wall so that they are not visible from the streets or from the surrounding residential spaces. To further mitigate its visual impact this roof plant is set back from the south and north façades by more than 10 metres.

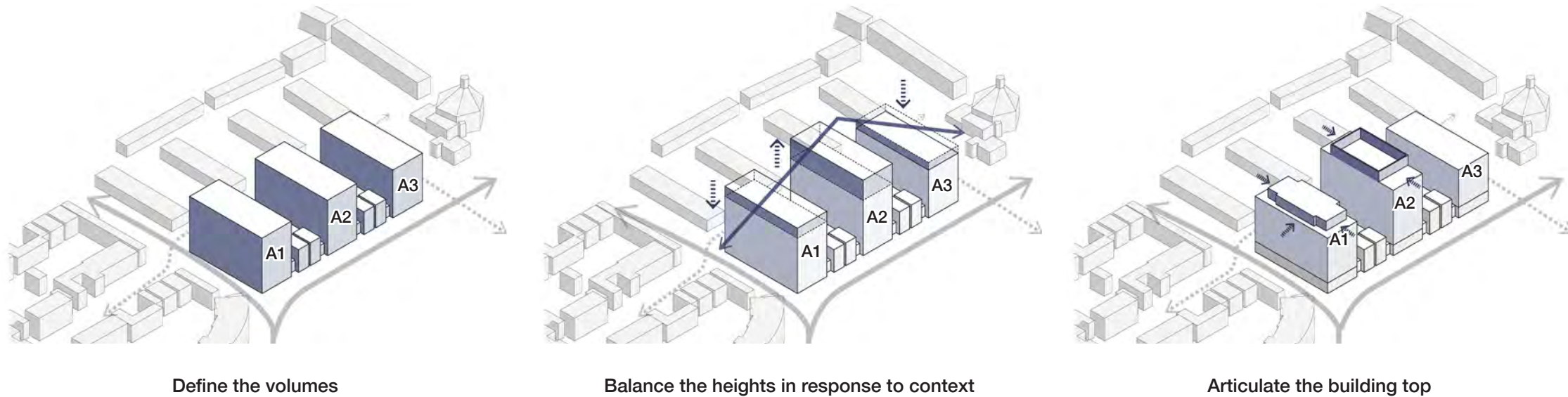

Figure 4.3: Massing articulation

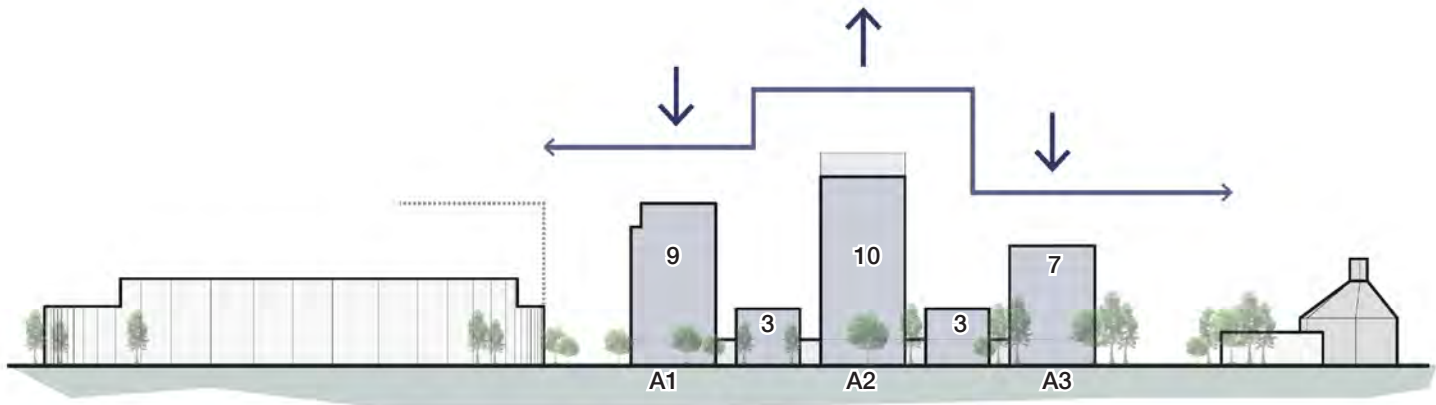

Figure 4.4: Section A indicating number of storeys (potential Douglas Bader development in dotted line): height decreases towards Clayton Field / St Augustine's

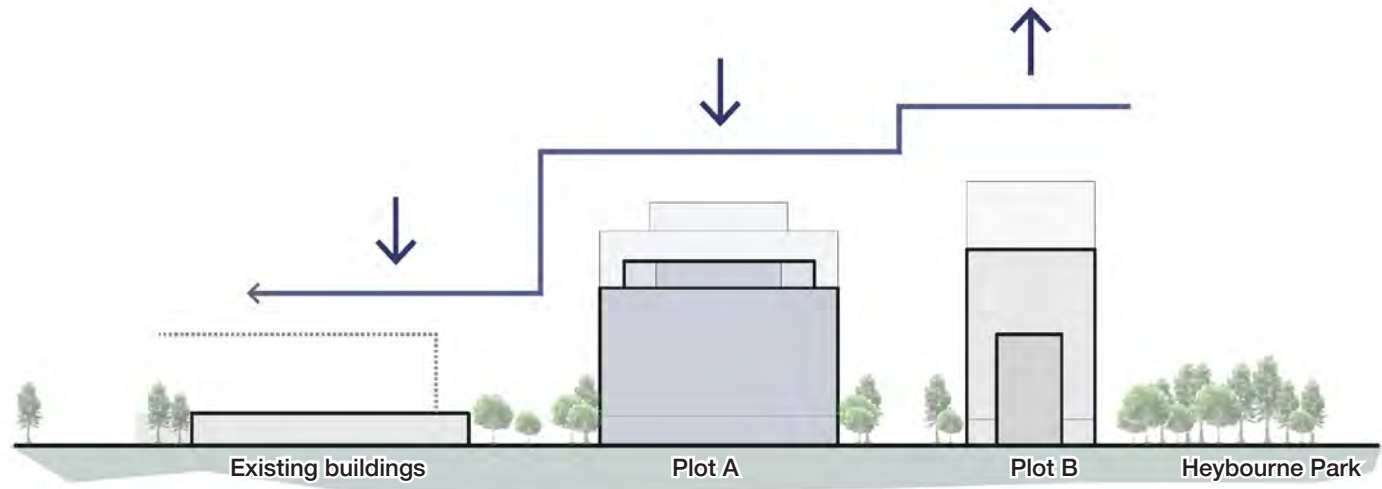

Figure 4.5: Section B (Orde building in the background shown in dotted line): height decreases towards Great Field

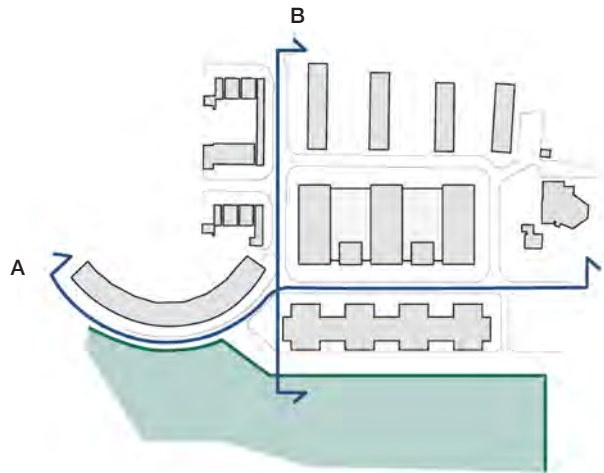

Figure 4.6: Key plan

4.0 Design strategy

4.4 Use

Ground floor use

Following the principles of the courtyard block typology, the ground floor podium will integrate all non-residential and ancillary functions.

A **commercial space** is proposed in Plot A, intended to accommodate a local supermarket. This commercial offer seeks to fulfil an existing need and benefit not only the new residents but also the surrounding communities.

The supermarket is strategically located on the south-west corner of the site which has been identified as the most prominent point due to its visibility from the park as well as from Heybourne Crescent. The entrance to the supermarket is to be located on Nighthawk Road (south), with service access located off Clayton Field (west). The pedestrian paving is enlarged to the south to provide spill out space adjacent to the supermarket entrance.

In addition to the supermarket, Nighthawk Road is animated by a sequence of residential entrances provided by the 3-storey houses, communal entrance to A2 and pair of 2-storey maisonettes in A3. These bring activity to the street and accentuate its importance. The homes along this street are provided with amenity spaces at ground floor to ensure good levels of privacy and a robust defensible space.

The north side will accommodate single storey ground floor accessible homes underneath the residential blocks as well as access to the residential car park. This street is designed to be a one-way secondary road predominantly used for residential access and to serve the existing garages opposite. Residential windows facing the street at ground level provide passive surveillance while high level windows are reduced to minimise overlooking.

The communal entrances to A1 and A3 face the west and east side streets respectively. These streets also provide service access to the substation and additional residential entrances.

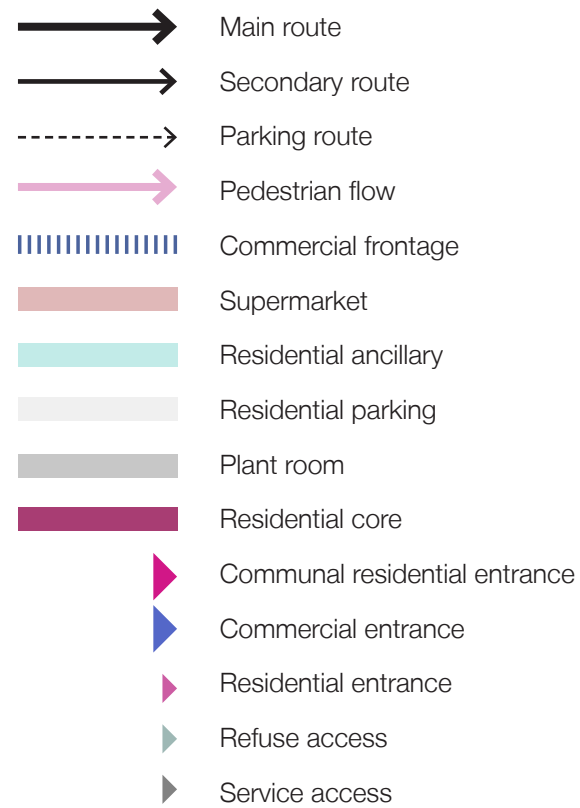

Figure 4.7: Ground Floor diagram

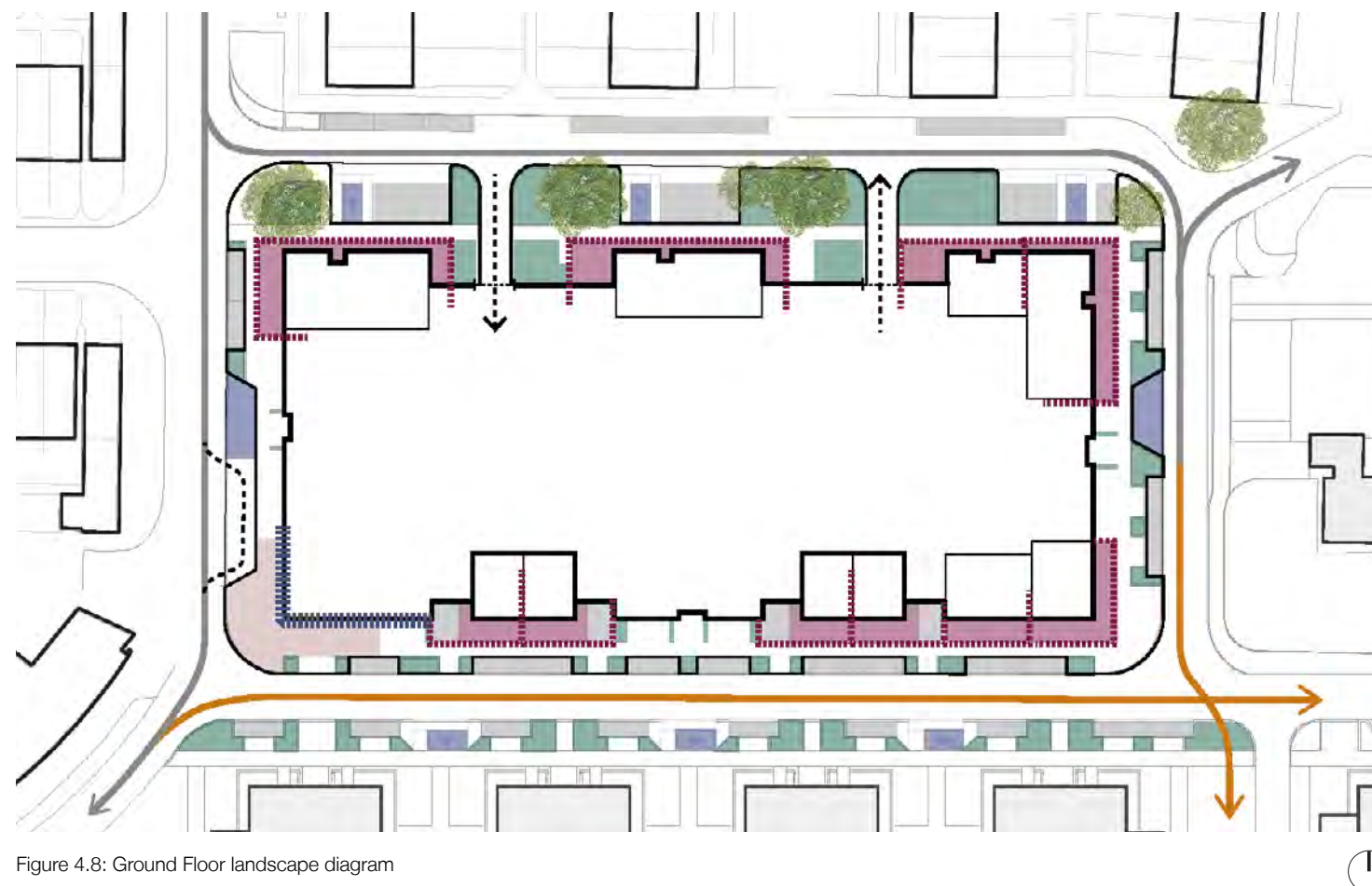
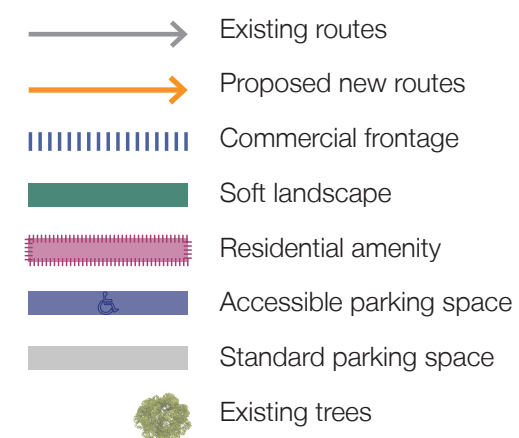

Figure 4.8: Ground Floor landscape diagram

4.0 Design strategy

Residential use

The residential component of Plot A will deliver 100% affordable homes split between **Social Rent** and **Affordable Shared Ownership**. These will be distributed in 5 blocks (A1-A5) and comprise a mixture of single level apartments, double storey maisonettes and 3 storey houses.

A demand has been identified in this project for step-free family homes of 3-4 bedrooms within the Social Rent tenure. This demand has been addressed in the form of single storey homes predominantly located at the lower levels of the building to improve ease of access and provide more generous amenity areas.

Blocks A1 and A2 will provide Affordable Shared Ownership homes at levels 01 and above and accessible Social Rent homes on the ground floor. The upper floor apartments are served by common cores accessed from the west and south streets respectively, whereas the ground floor homes will have private entrances off Great Field.

Blocks A3, A4 and A5 will provide Social Rent homes which will range from single bedroom apartments in A3 up to a 5-bedroom house in A5. All flats in A3 are accessed from the west street via the common core, with all ground floor homes being provided with private entrances and amenity spaces at grade.

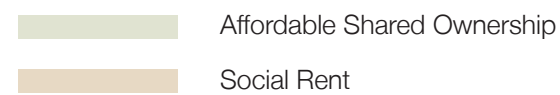
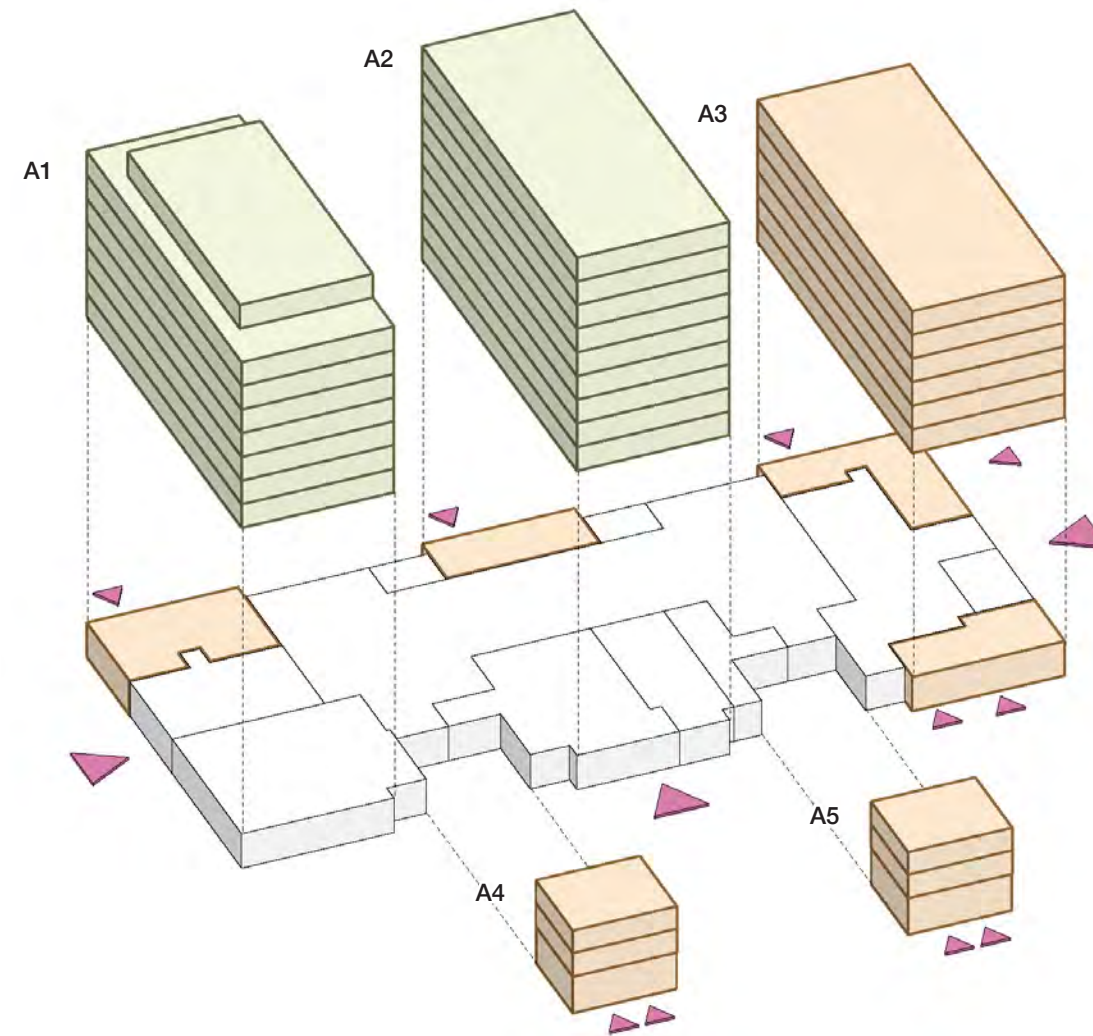

Figure 4.9: Tenure diagram

4.5 Residential floorplate configuration

The residential floorplans are configured to maximise orientation, aspect and views while generating an efficient floor plan that delivers rational internal arrangements. This is achieved by applying the following measures:

Core location

All cores are located on courtyard façades. This frees up the street façades for residential use which maximises daylight opportunities.

Core offset

The core of A2 is moved south to improve the efficiency of the car park layout and reduce the distance between the core and building entrance.

Aspect

2-bedroom homes are located at the north and south ends of the blocks, enjoying the opportunity for double aspect. Smaller 1-bedroom homes will occupy the centre of the plans facing west or east, street or courtyard. This arrangement ensures that there are no north facing single aspect homes in the scheme. Family homes (2-5 bedrooms) achieve 99% dual aspect rate.

Internal spaces

This floorplate arrangement results in a very rational grid to the apartments which improves the building efficiency and ease of construction. The off-centre position of the cores avoids the creation of undesirable spaces behind lift shafts or stairs, improving the quality of the internal spaces in adjacent homes.

The corner 2-bedroom homes will have single aspect bedrooms facing east or west and open space kitchen living dining rooms provided with level access to balconies and making the most of the opportunity for double aspect.

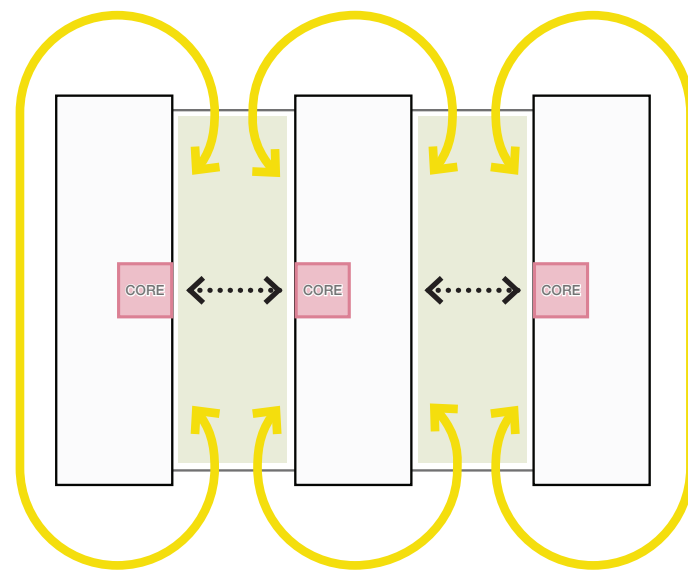

Locate cores to maximise frontage and aspect

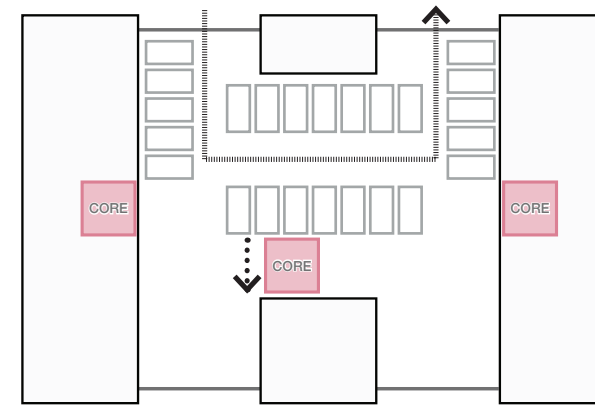

Offset central core for parking circulation

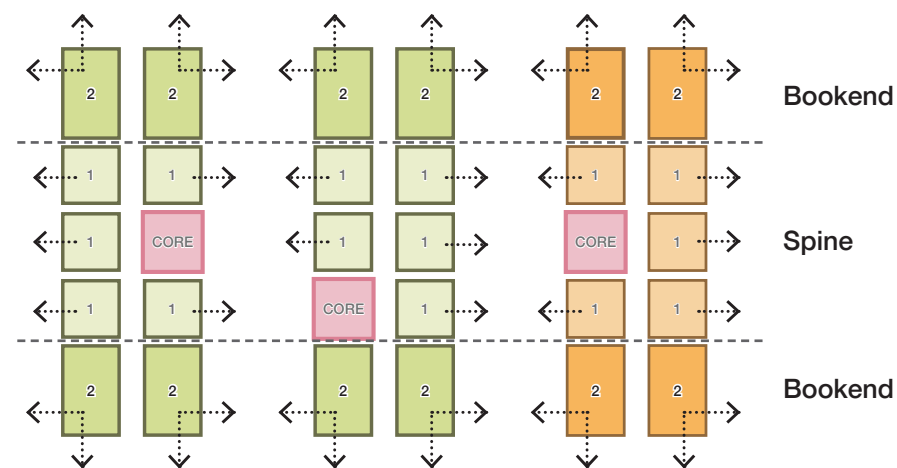

Maximise double aspect to larger homes

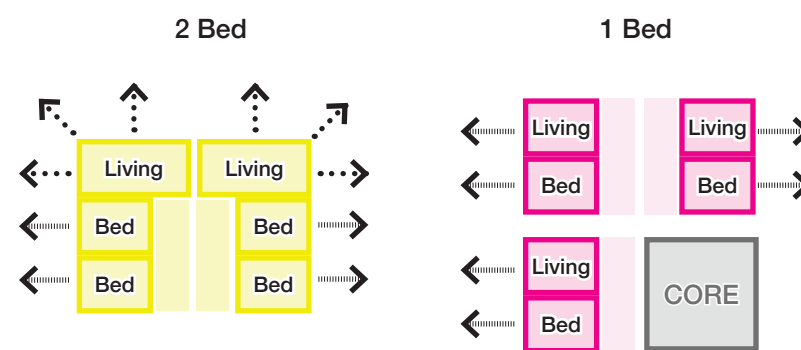

2 Bed: corner living room

1 Bed: rational plan

4.0 Design strategy

A choice of different homes

The floorplate configuration principles are applied to the upper floors of Plot A following an efficient stack at all levels. The top floor of A1 takes advantage of the volumetric set-back defined by the townscape strategy to provide generous residential terraces at the 8th floor.

The east block (A3) has the most variety in terms of size and configuration. With a mix driven by the re-provision needs of the decant strategy, this block offers 1 and 2-bedroom homes at the upper floors, 2-storey double aspect maisonettes at ground and first floors and accessible single storey homes at ground and first floors.

All courtyard facing homes at first floor will have access to private terraces as well as direct access to the shared courtyard gardens.

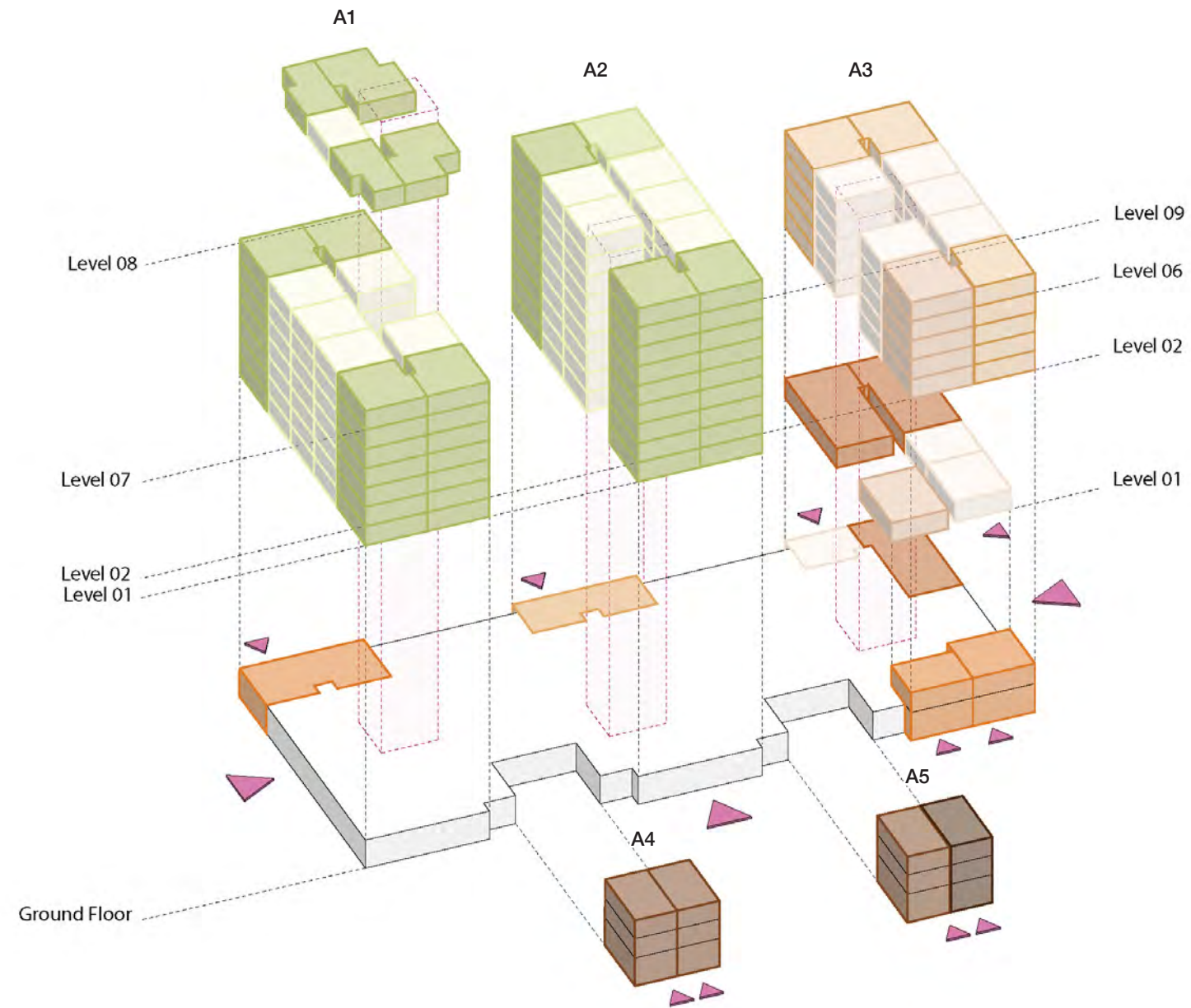

Affordable Shared Ownership		Social Rent	
	1B2P		1B2P
	2B3P		2B3P
	2B4P		3B6P
			4B5P
			4B6P
			5B6P

Figure 4.11: Residential mix diagram

4.0 Design strategy



Figure 4.12: Photovoltaic panels on the roof



Figure 4.13: Biodiverse roof



Figure 4.14: Biodiverse roof



Figure 4.15: Existing tree to be retained

4.6 Environmental design

Biodiversity

- Biodiverse roofs.
- Considerate planting strategy with a view to enhance biodiversity as much as possible.
- Existing trees retained where possible and protected during construction works.

Energy

- Use of Air Source Heat Pumps and low temperature distributed heating system.
- Provision of PVs where possible to maximise renewable energy.

Sustainable drainage systems (SUDS)

- Maximise opportunities for rainwater attenuation by providing biodiverse roofs, courtyard gardens, planted trenches and permeable paving.
- Harvesting and re-circulating of rainwater back into the courtyards for drip-irrigation of gardens.

Air quality

- Located within an Air Quality Management Area, the development is air quality neutral. Mitigation measures will be put in place to monitor and control dust and hazardous particles during construction phase.

Overheating

- Prevent overheating exclusively via passive ventilation systems and without the need for active cooling systems;
- Considerate fenestration design and provision of shading at the top south facing windows.
- Maximise cross ventilation opportunities where possible by providing openable windows in both façades to all double aspect rooms.

Noise

- Specialist modelling has revealed that the proposed development will have a beneficial impact to the surrounding properties north of Great Field, as the new building will act as a shield from traffic noise.
- Plant equipment on the roof of A2 located at a reasonable distance from residential windows and screened so as to not have a negative impact on the adjacent dwellings.
- Plot A windows and ventilation openings provided with a suitable acoustic rating.

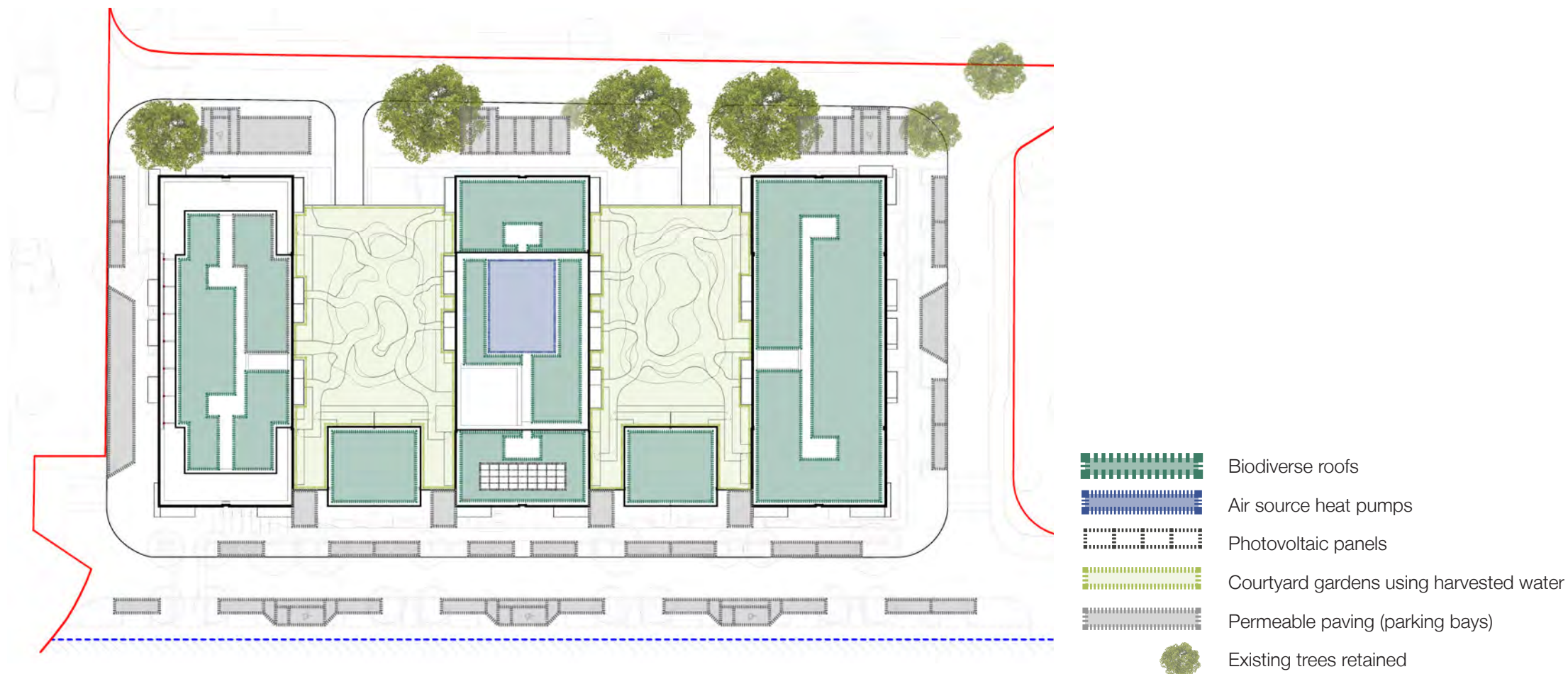

Figure 4.16: Key plan - environmental design

4.0 Design strategy

4.7 Sustainability

Plot A has been designed to satisfy the London Plan carbon reduction methodology, perform at least 10% better than current building regulation requirements (residential) and reduce carbon emissions by 35% over building regulation targets. The approach follows the “Be Lean, Be Clean, Be Green” philosophy.

Be Lean

- Efficient fabric: high levels of insulation, low levels of air leakage, minimising of cold bridging.
- Efficient glazing and window to wall area ratio.
- Mechanical Ventilation with Heat Recovery units.

Be Clean

- Provision of new energy centre to serve Plots A and B, designed to allow for a potential connection into a future area wide heat network.

Be Green

- Provision of a heat network using Air Source Heat Pumps as the primary source to deliver domestic hot water.
- Stacking HIU cupboards accessed from communal areas reduce network heat losses.
- Photovoltaic panels on the roof of the tallest block.

Be Seen

- The building’s energy usage will be monitored through installation of smart meters.

Healthy streets

- Encouraging cycling via provision of secure cycle parking for residents, cycle parking for visitors in the public realm and design of streets to be cyclist and pedestrian friendly.
- Promoting use of low carbon transport by providing electrical vehicle charging points (20% active, 80% passive at completion).
- Encouraging the use of public transport via the site-wide strategy to improve bus connections.
- Maximising the landscape offer on site including street planting, trees and courtyard gardens.

Recycling

- Encouraging recycling by providing recycling bins in each home and communal recycling storage in accessible locations. Dedicated recycling bins with kerbside collection are created for homes at ground floor.



Figure 4.17: Courtyard gardens



Figure 4.18: Courtyard gardens



Figure 4.19: Planting on streets

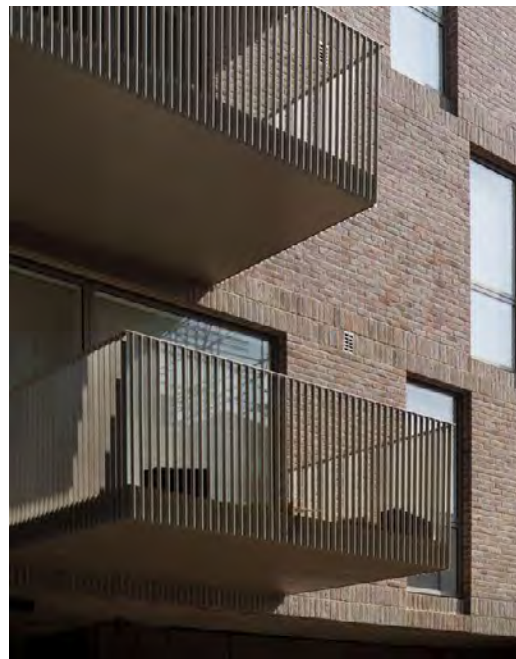

Figure 4.20: Balcony amenity



Figure 4.21: Cycle racks in the public realm



Figure 4.22: Secure cycle storage for residents

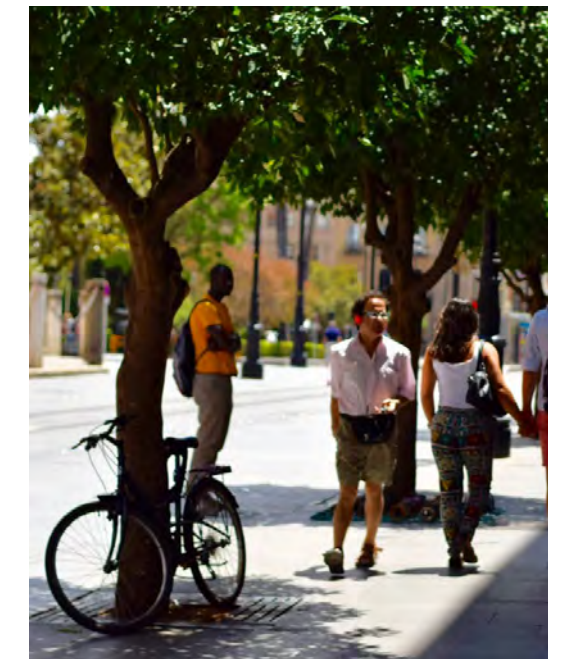

Figure 4.23: Green streets



Figure 4.24: Balcony amenity

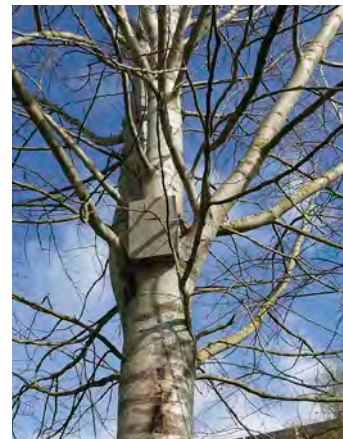

Figure 4.25: Urban habitats



Figure 4.26: Urban habitats



Figure 4.27: Urban habitats



Figure 4.28: Residential terraces